

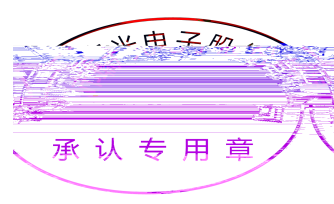

3
3
3
3
4
5
7
10
10

11
12
13
14
14
16
16

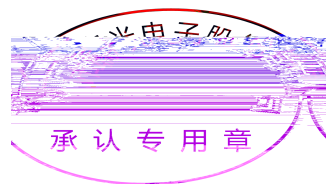

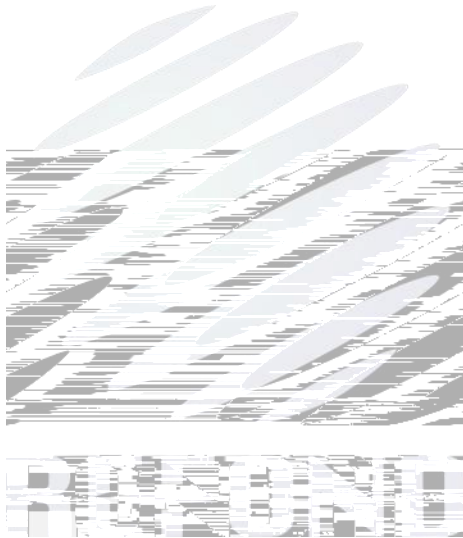
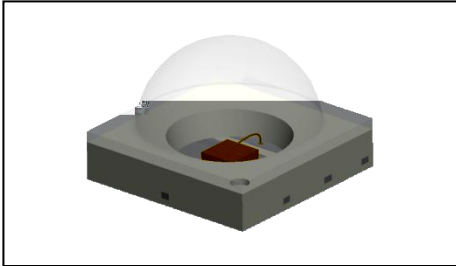

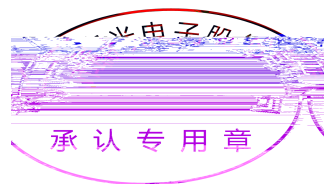
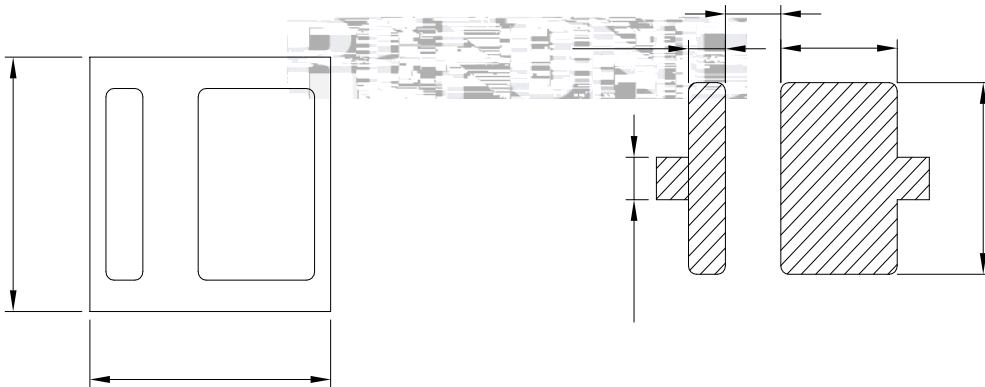
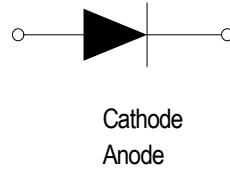
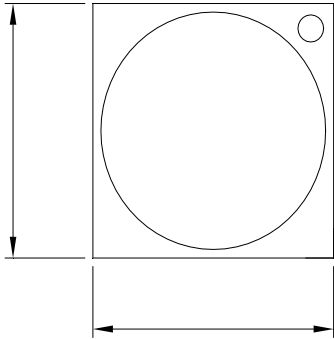

	λ					

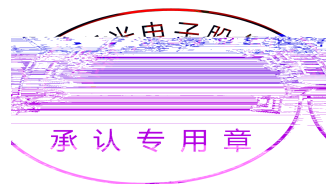

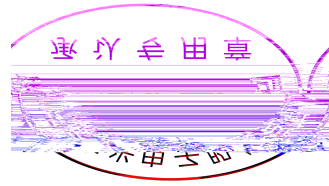

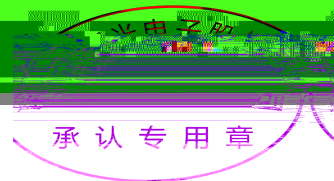
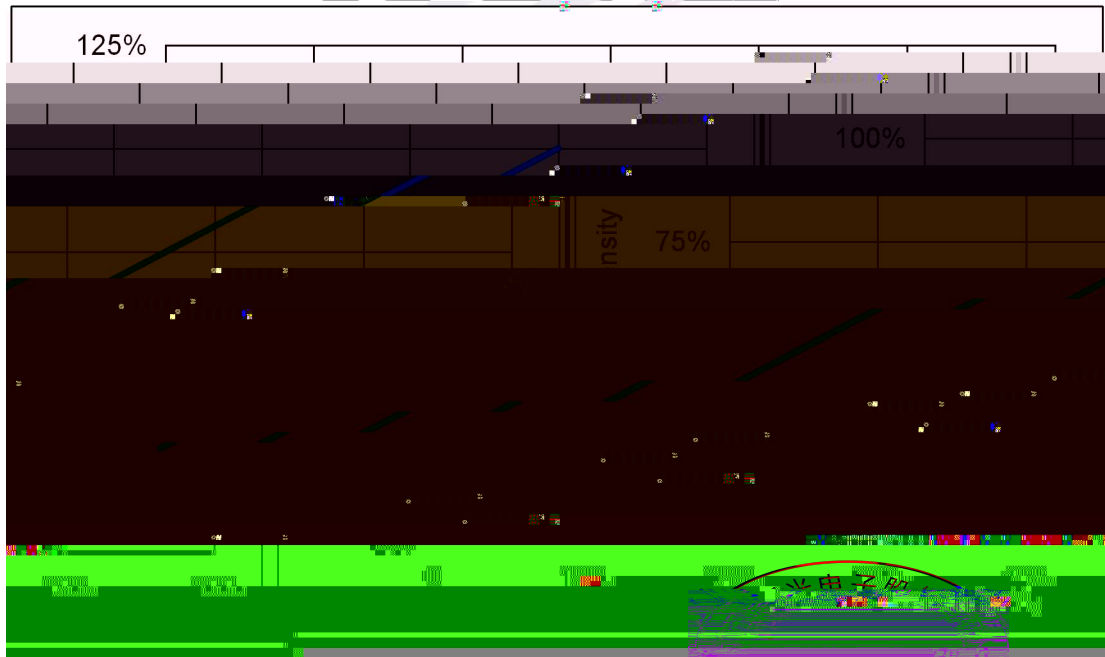
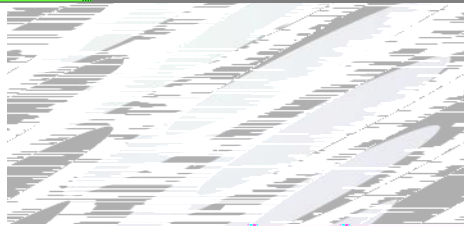
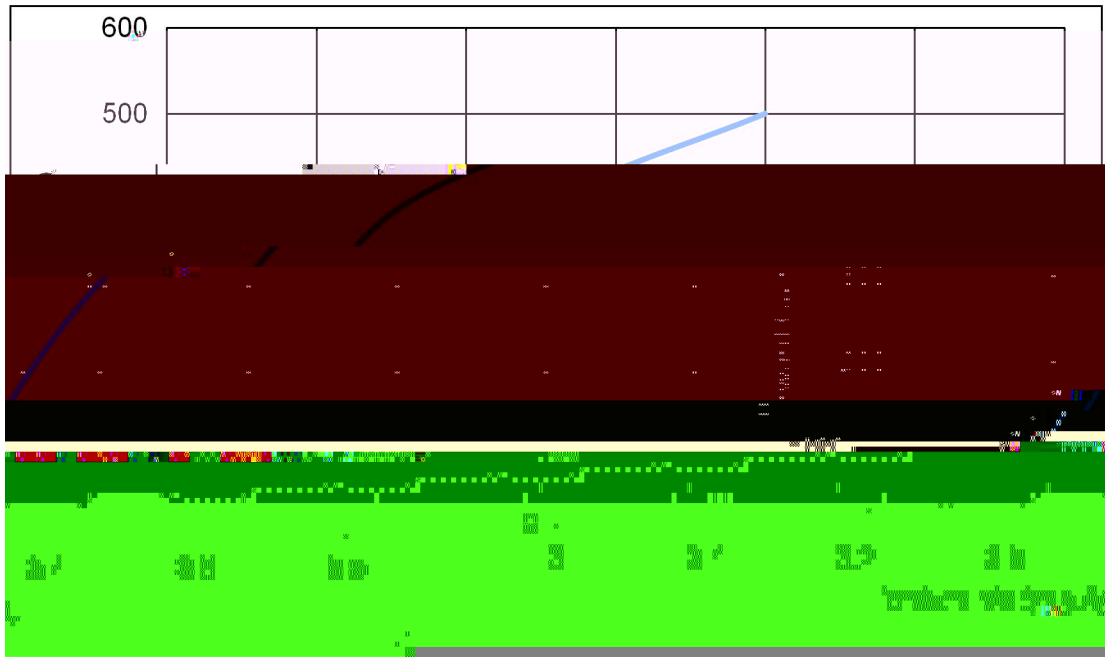

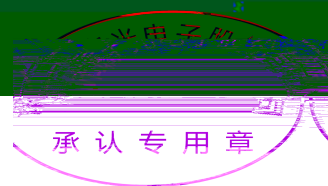
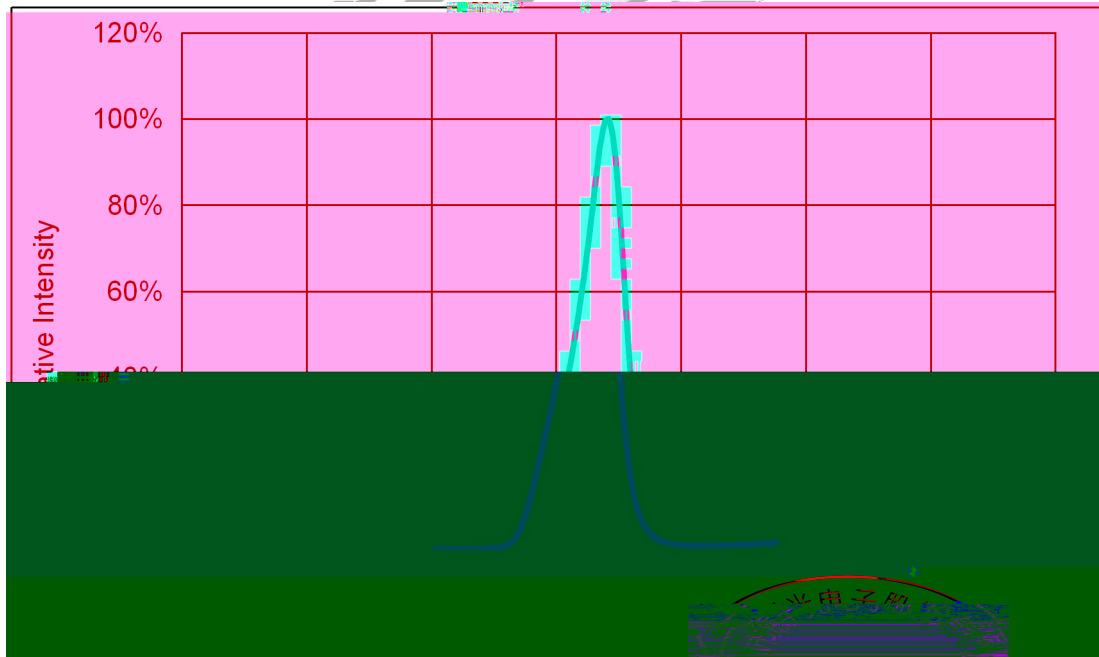
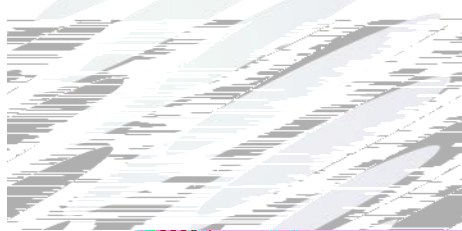
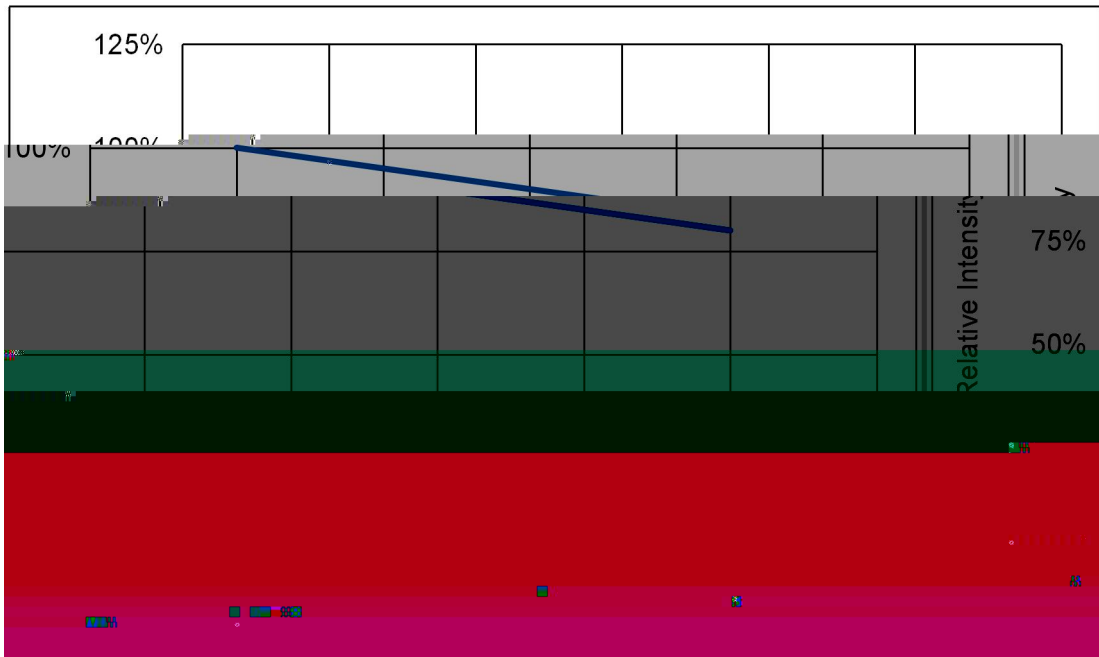

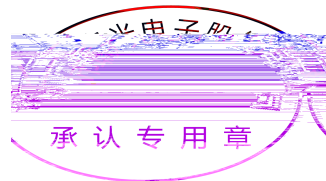
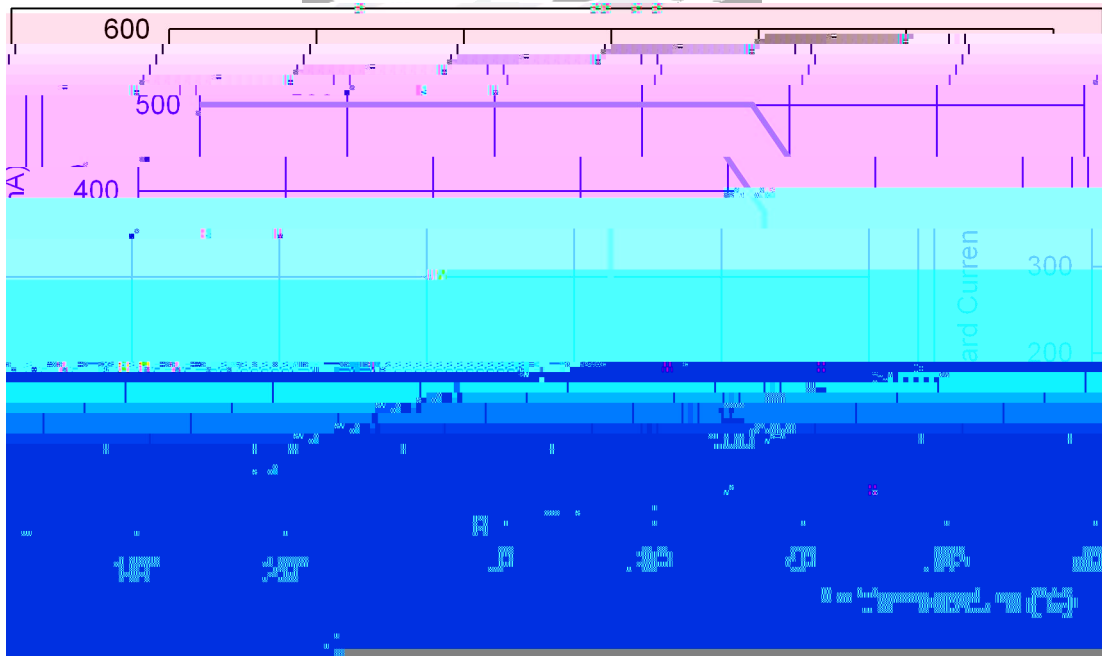
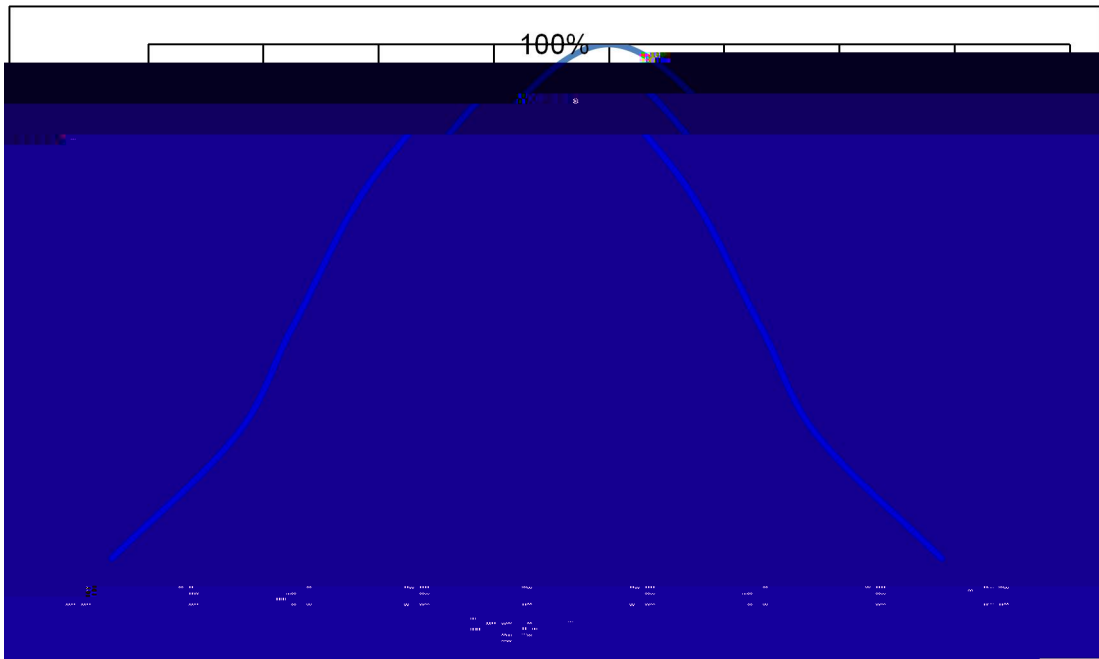

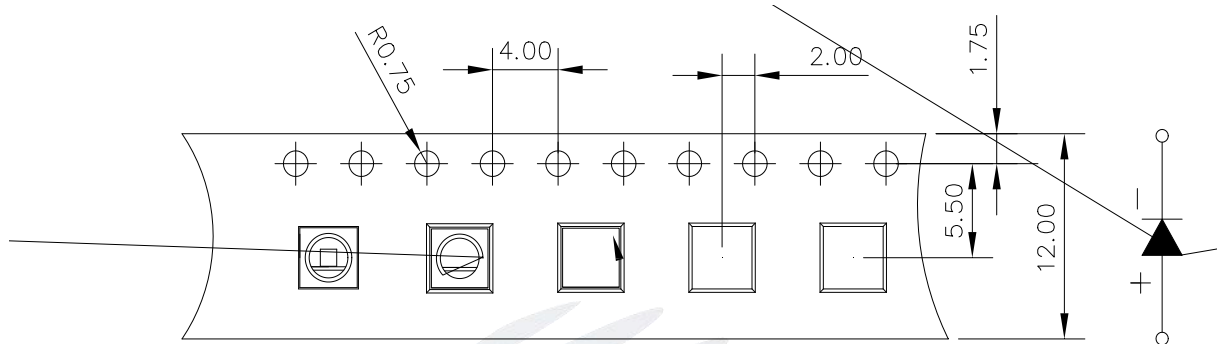

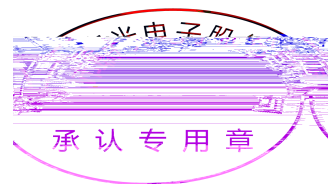
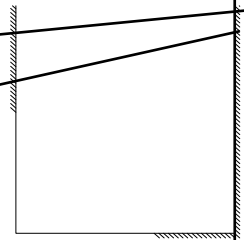
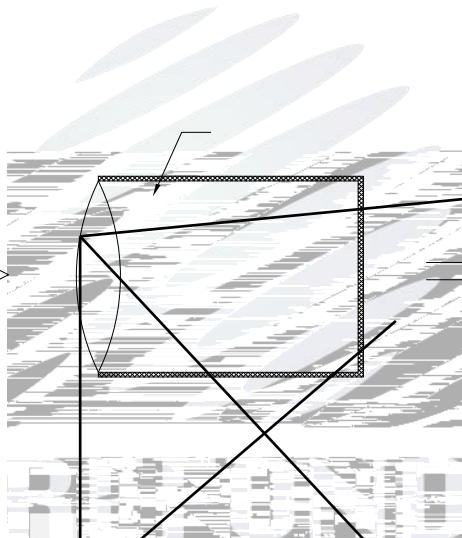
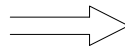
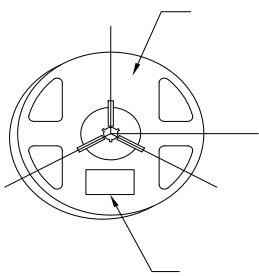

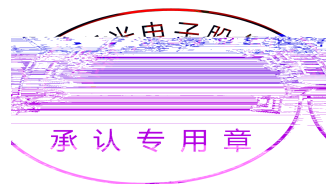

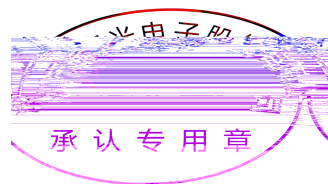

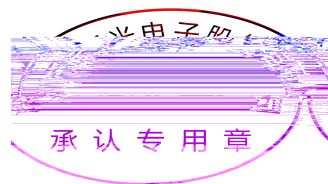

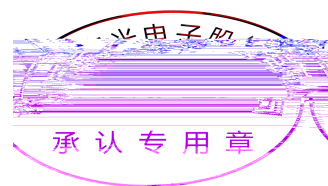
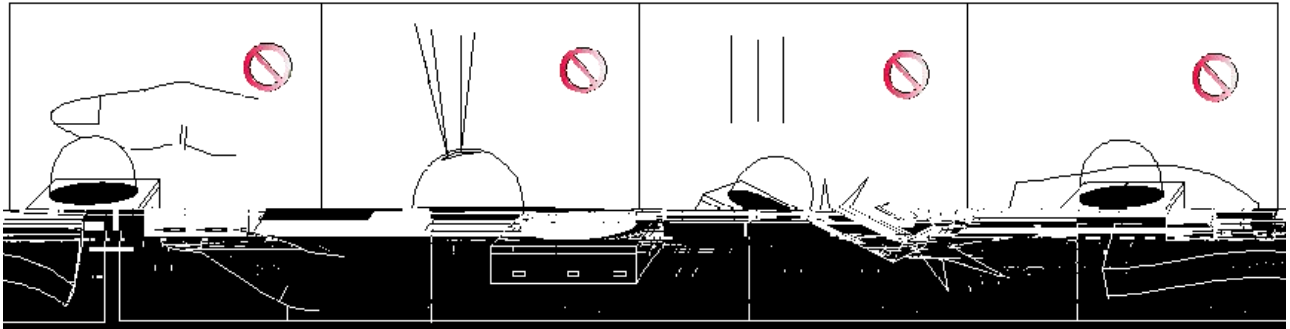



±

