



SPECIFICATION



REFOND P/N

RF-BWRA30DS-KK-BZ

R&D

Mass Production





Contents

1. Description	3
1.1 General Description	3
1.2 Features	3
1.3 Application	3
1.4 Package Dimension	4
1.5 Product Parameters	5
1.6 Bin Range Of Forward Voltage and Luminous Intensity (IF=5mA)	BIN
(IF=5mA)	6
1.7 Typical Optical Characteristics Curves	8
2. Packaging	12
2.1 Packaging Specification	12
2.1.1 Carrier Tape Dimension	12
2.1.2 Reel Dimension	12
2.1.3 Label Form Specification	13
2.2 Moisture Resistant Packing	13
2.3 Cardboard Box	13
2.4 Reliability Test Items And Conditions	14
2.5 Criteria For Judging Damage	15
3. SMT Reflow Soldering Instructions SMT	16
3.1 SMT Reflow Soldering Instructions SMT	16
4. Handling Precautions	18
4.1 Handling Precautions	18



1. Description

1.1 General Description

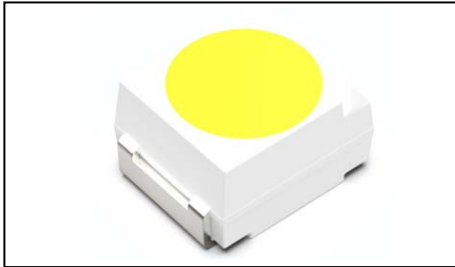

The White LED, which was fabricated by using a blue chip and the phosphor.

Product Package: 3.50mmX2.80mmX1.84mm.

LED

3.50mmX2.80mmX1.84mm.

1.2 Features

PLCC2 Package. PLCC2

Extremely wide viewing angle.

Suitable for all SMT assembly and solder process. SMT

Available on tape and reel.

Moisture sensitivity level: Level 2. Level2

Compliance with RoHS and REACH. 符合RoHS和REACH要求

Qualifications: The product qualification test plan is based on the guidelines of AEC-Q101 Stress Test Qualification for Automotive Grade Discrete Semiconductors

AEC-Q101

1.3 Application

Automotive Interior Lighting. 汽 内 照明

Switches. 开关





1.4 Package Dimension

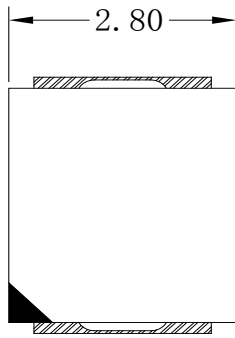

Notes

- 1. All dimensions units are millimeters.
- 2. All dimensions tolerances are ± 0.2 mm unless otherwise noted.



1.5 Product Parameters

Table 1-1 Electrical / Optical Characteristics at Ts=25°C

Item	Symbol	Test Condition	Value			Unit
			Min.	Typ.	Max.	
Forward Voltage	V_F	$I_F=5mA$	2.5	2.7	3.1	V
Reverse Current	I_R	$V_R=5V$	---	---	10	μA
Luminous Intensity	I_V	$I_F=5mA$	150	190	280	mcd
Viewing Angle		$I_F=5mA$	---	120	---	deg
Thermal Resistance.	R_{THJ-S}	$I_F=5mA$	---	---	300	/W

Table 1-2 Absolute Maximum Ratings at Ts=25°C

Parameter	Symbol	Rating	Units
Power Dissipation	P_D	93	mW
Forward Current	I_F	30	mA
Peak Forward Current	I_{FP}	50	mA
Reverse Voltage	V_R	5	V
Electrostatic Discharge (HBM)	E_{SD}	8000	V
Operating Temperature	T_{OPR}	-40 ~ +100	
Storage Temperature	T_{STG}	-40 ~ +100	
Junction Temperature	T_J	120	

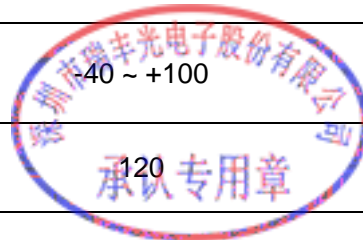

Notes

1. 1/10 Duty cycle,10ms pulse width. 10ms, 1/10.
2. The above forward voltage measurement allowance tolerance is $\pm 0.1V$. $\pm 0.1V$.
3. The above color coordinates measurement allowance tolerance is ± 0.005 . ± 0.005 .
4. The above luminous intensity measurement allowance tolerance $\pm 10\%$.
 $\pm 10\%$.
5. Care is to be taken that power dissipation does not exceed the absolute maximum rating of the product.
6. All measurements were made under the standardized environment of Refond.
7. When the LEDs are in operation the maximum current should be decided after measuring the package temperature, junction temperature should not exceed the maximum rate. LED
8. ESD yield is over 90% at 8000V ESD (HBM). ESD protection during products handing is needed. 90% LED
 ESD8000V

1.6 Bin Range Of Forward Voltage and Luminous Intensity (IF=5mA)

BIN (IF=5mA)

Table 1-3

V _F V	E2	F1	F2	G1	G2	H1
	2.5-2.6	2.6-2.7	2.7-2.8	2.8-2.9	2.9-3.0	3.0-3.1
IV(mcd)	H1	H2	I1			
	150-180	180-230	230-280			



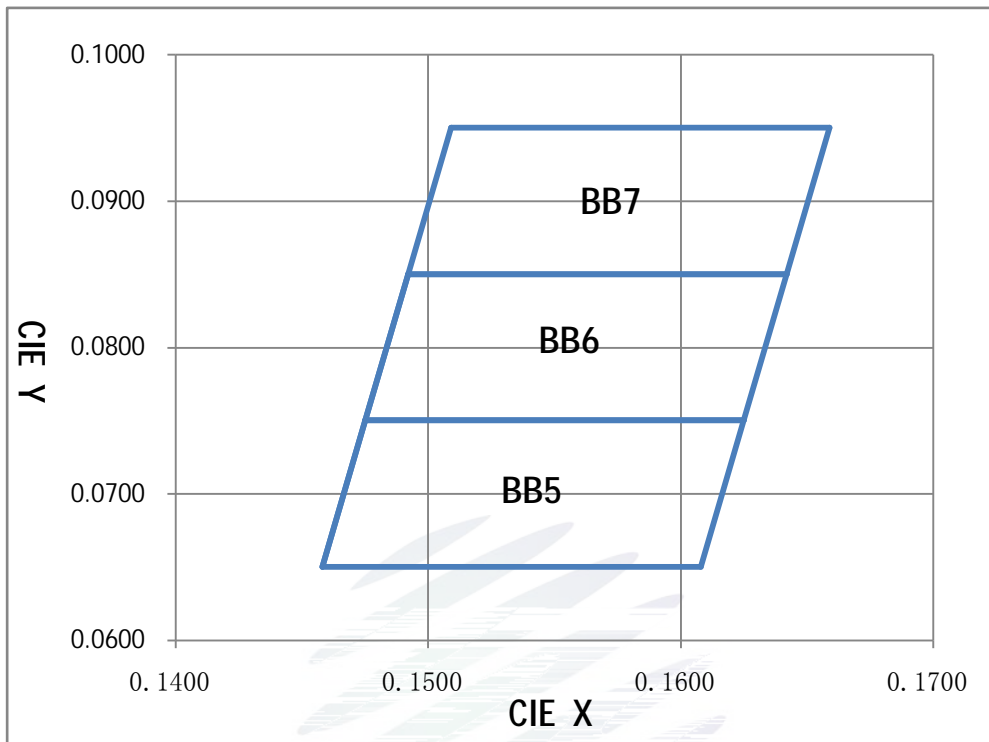

Fig. 1-6 The C.I.E Chromaticity Diagram CIE

Table 1-4

BIN CODE	CIE-X1	CIE-Y1	CIE-X2	CIE-Y2	CIE-X3	CIE-Y3	CIE-X4	CIE-Y4
BB5	0.1458	0.0650	0.1475	0.0750	0.1625	0.0750	0.1608	0.0650
BB6	0.1475	0.0750	0.1492	0.0850	0.1642	0.0850	0.1625	0.0750
BB7	0.1492	0.0850	0.1509	0.0950	0.1659	0.0950	0.1642	0.0850





1.7 Typical Optical Characteristics Curves

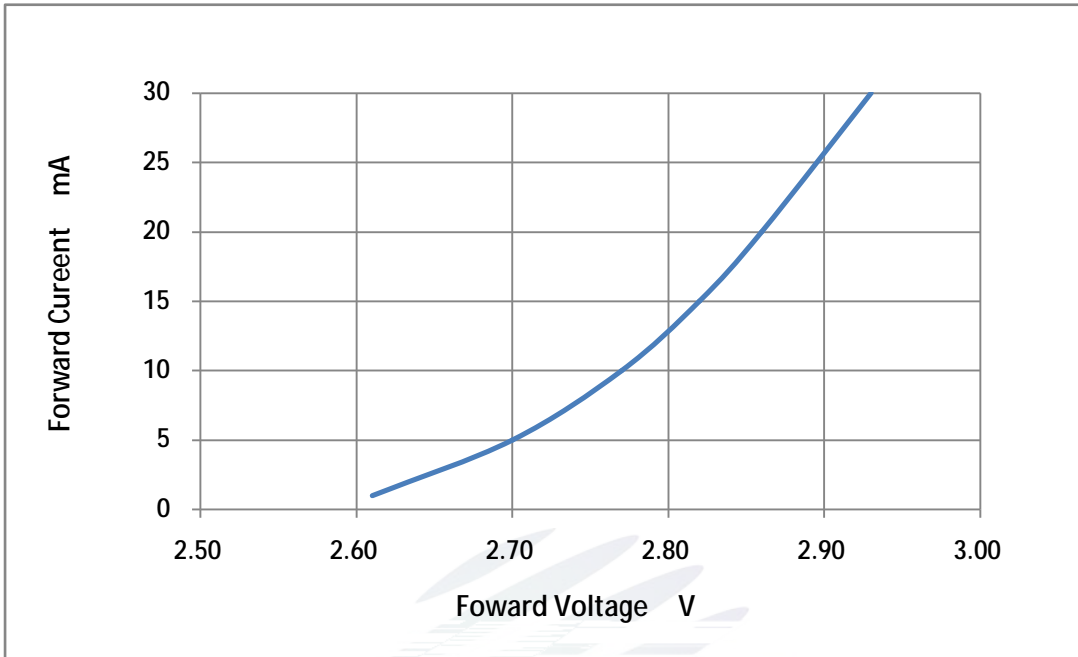

Fig. 1-7 Forward Voltage Vs Forward Current

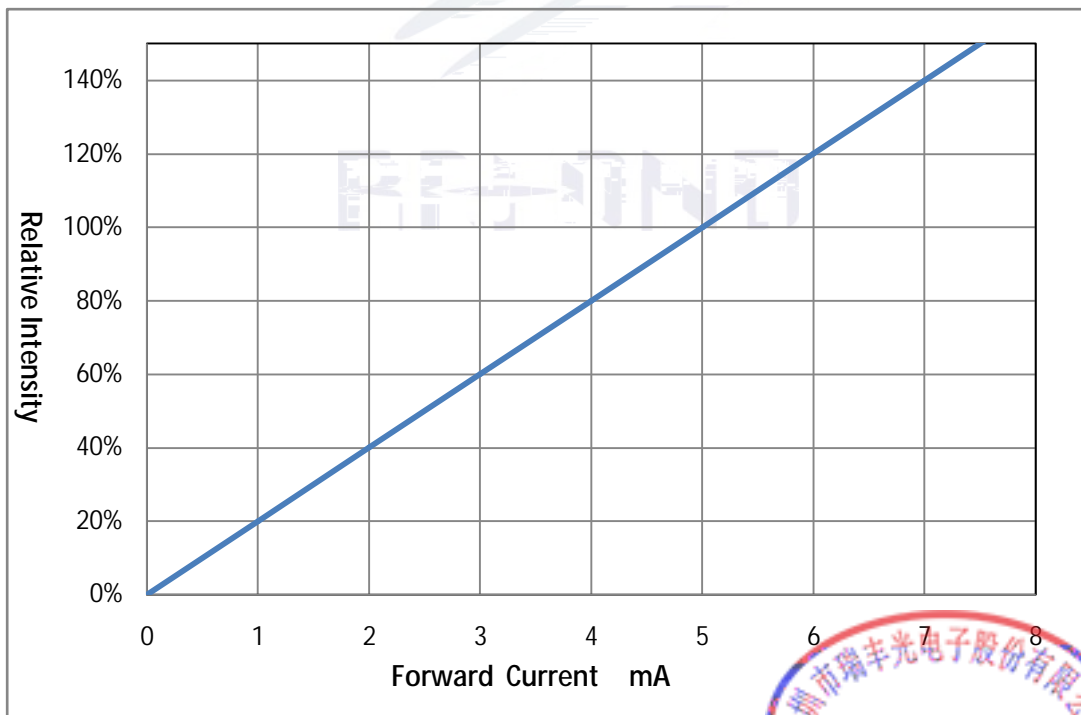
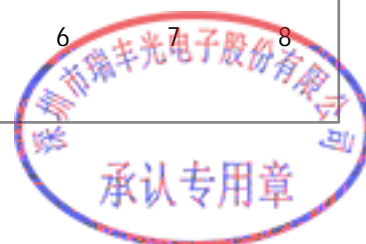

Fig. 1-8 Forward Current Vs Relative Intensity



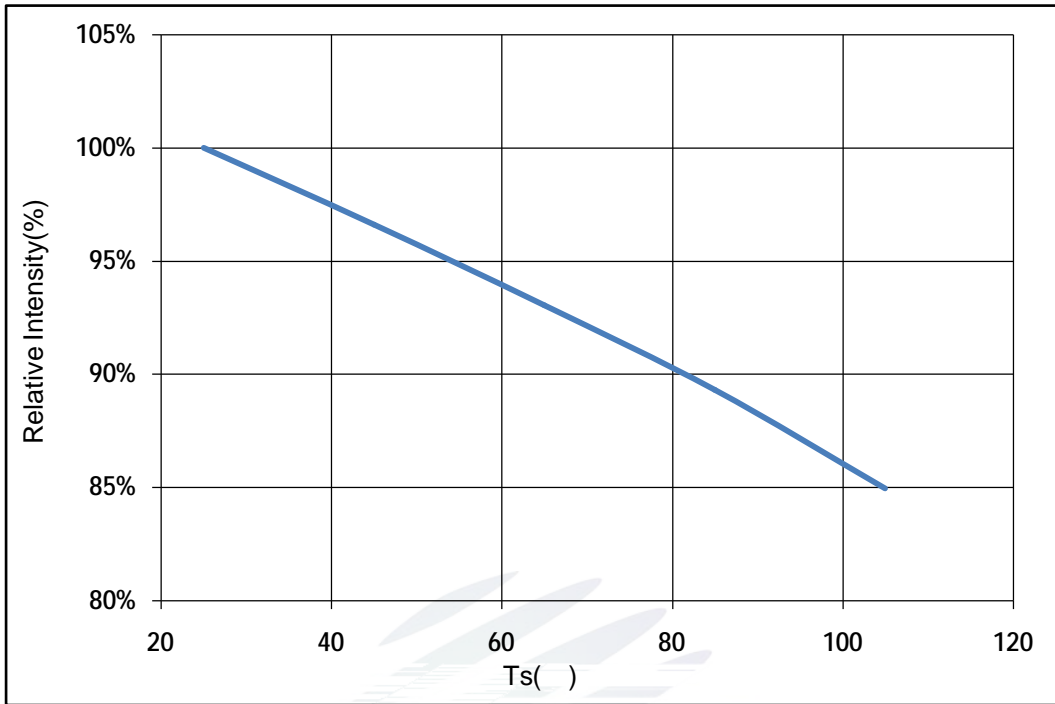

Fig. 1-9 Solder Temperature Vs Relative Intensity

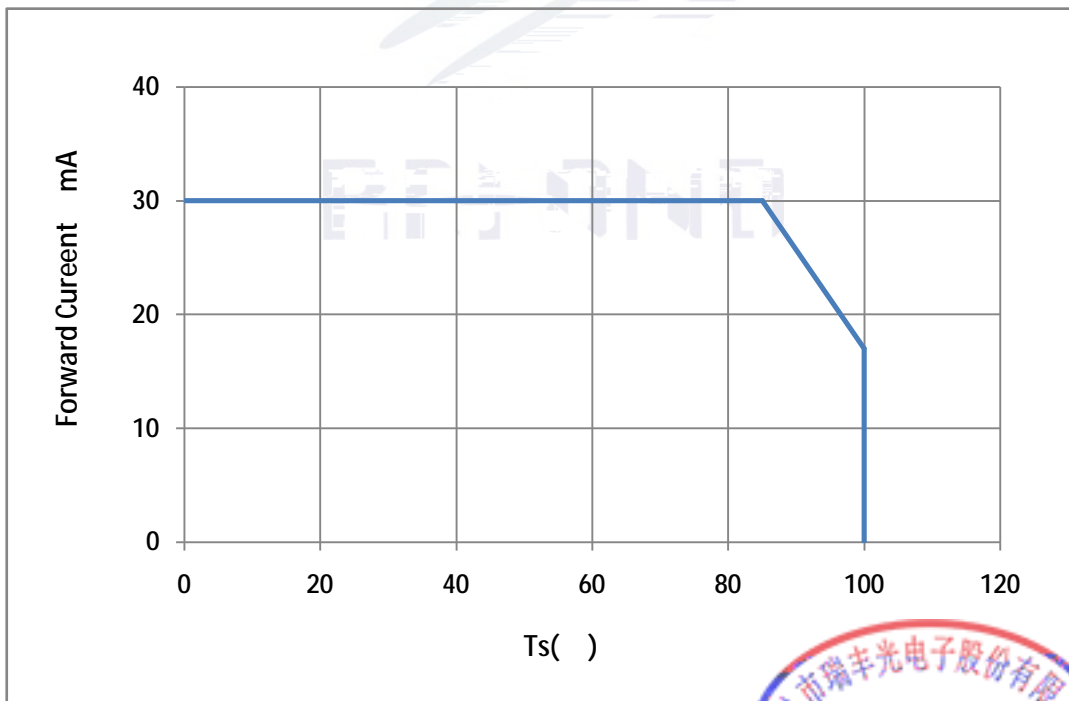

Fig. 1-10 Solder Temperature Vs Forward Current



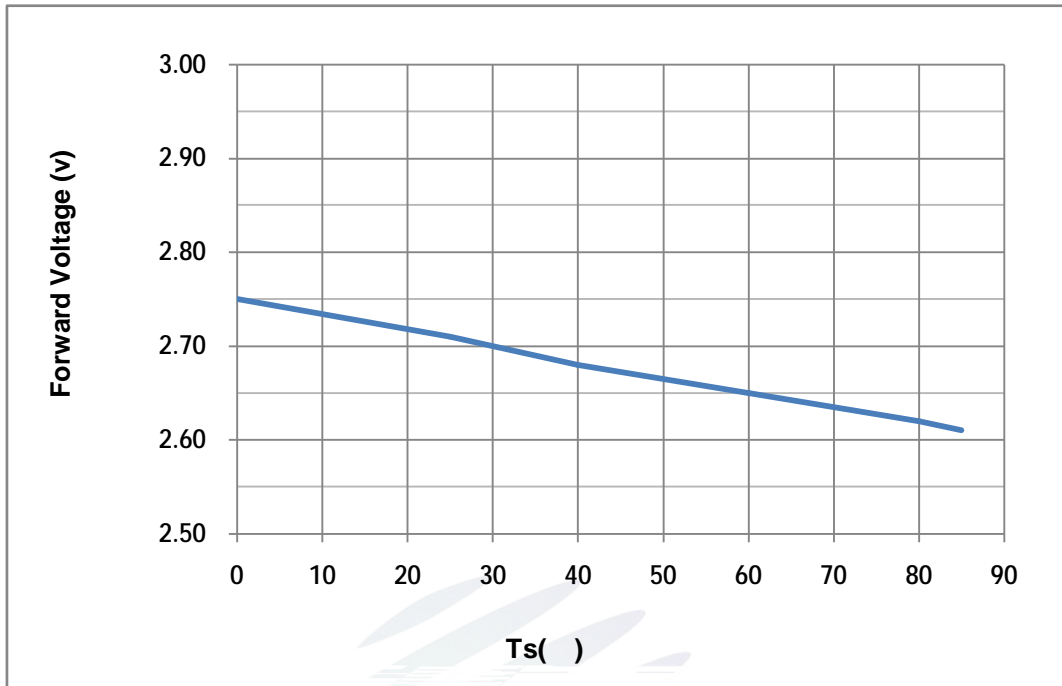

Fig. 1-11 Forward Voltage Vs Solder Temperature

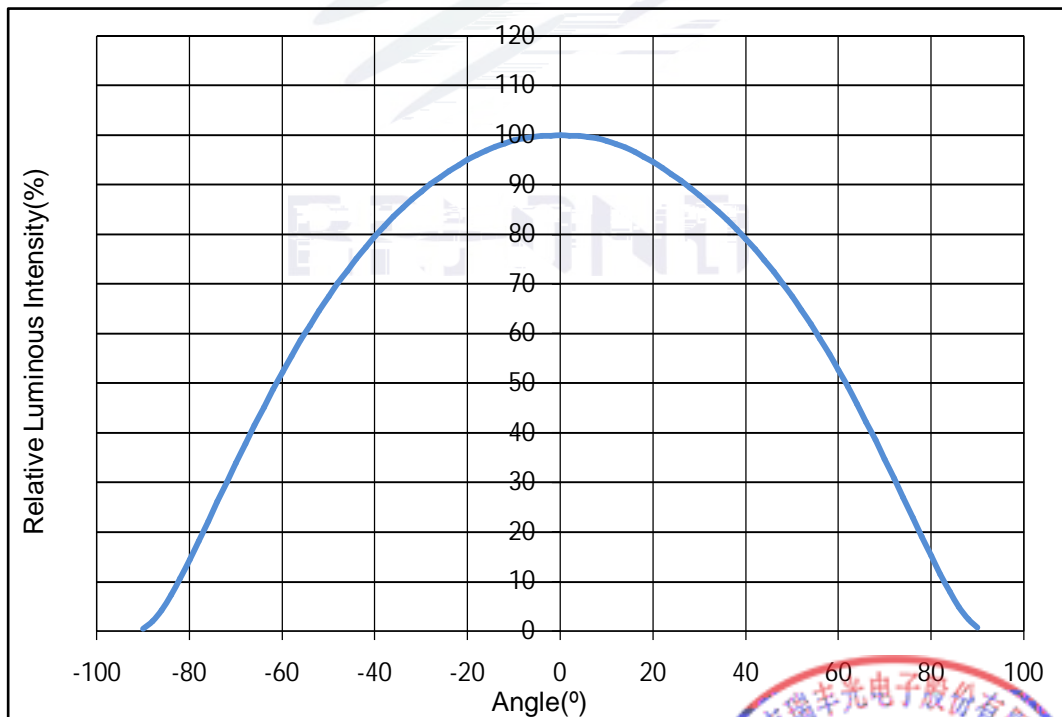
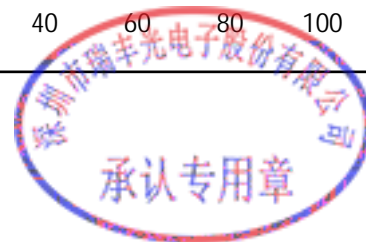

Fig. 1-12 Radiation diagram



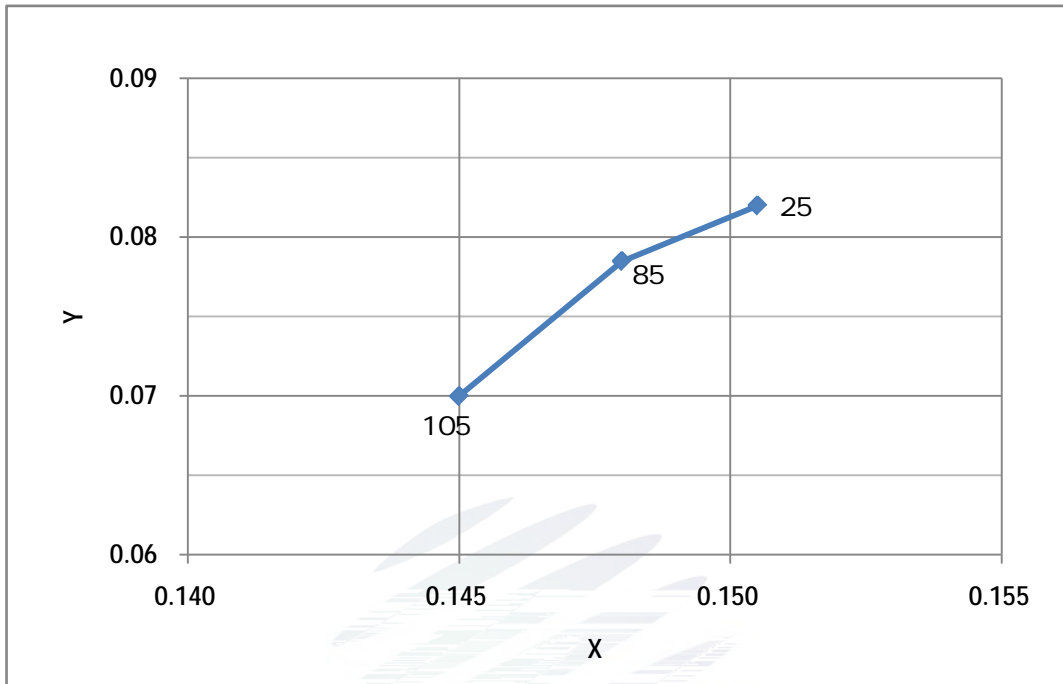

Fig. 1-13 Solder Temperature vs. Color Shift

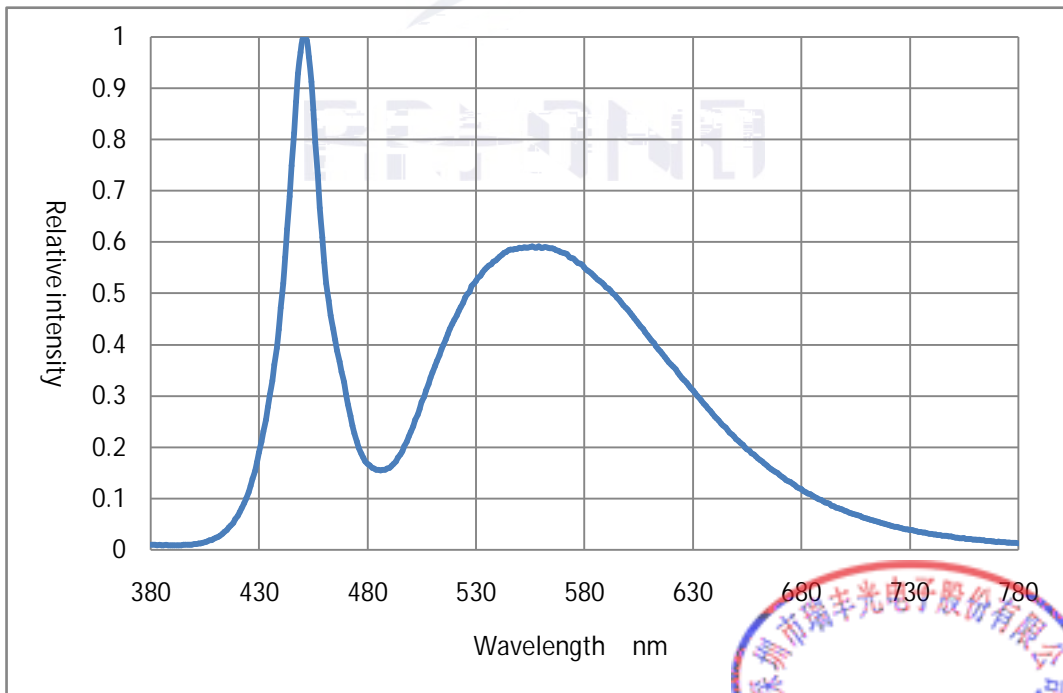
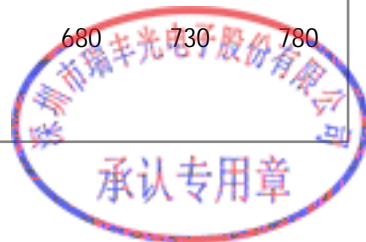

Fig. 1-14 Spectrum Distribution



2. Packaging

2.1 Packaging Specification

Package: 2000pcs/reel. 2000pcs

2.1.1 Carrier Tape Dimension

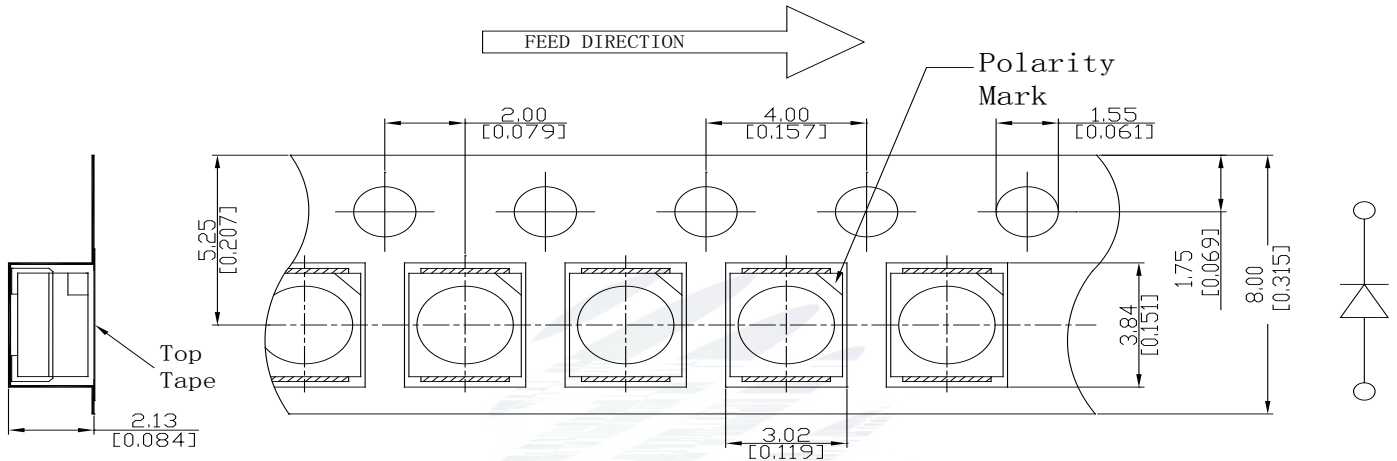

Fig.2-1 Carrier Tape Dimension

2.1.2 Reel Dimension

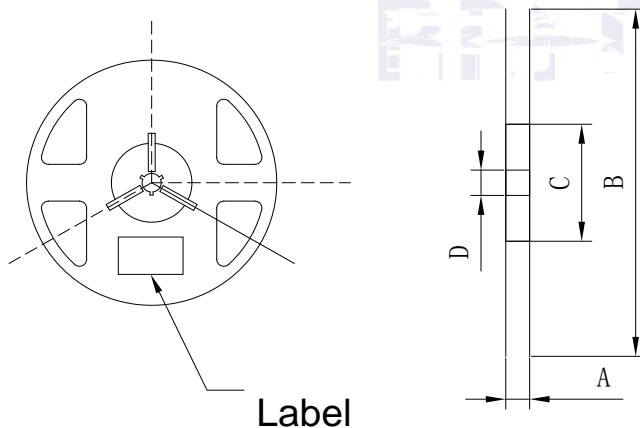

Fig.2-2 Reel Dimension

Table 2-1 Reel Dimension

A	8.0± 0.1mm
B	178± 1mm
C	60± 1mm
D	13.0± 0.5mm

Notes

The tolerances unless mentioned ± 0.1 mm. Unit : mm

± 0.1



2.1.3 Label Form Specification

Table 2-2 Specification

PART NO.	Part Number
SPEC NO.	Spec Number
LOT NO.	Lot Number
BIN CODE	Bin Code
	Luminous flux
XY	Chromaticity Bin
V _F	Forward Voltage
WLD	Wavelength
QTY	Packing Quantity
DATE	Made Date

Fig. 2-3 Label Form Specification

2.2 Moisture Resistant Packing

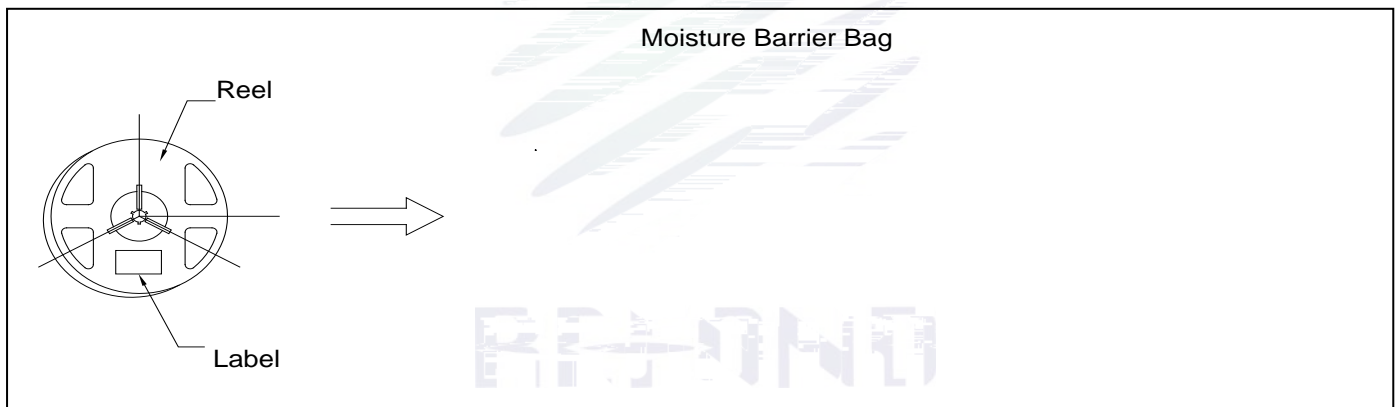

Fig.2-4 Moisture Resistant Packing

2.3 Cardboard Box

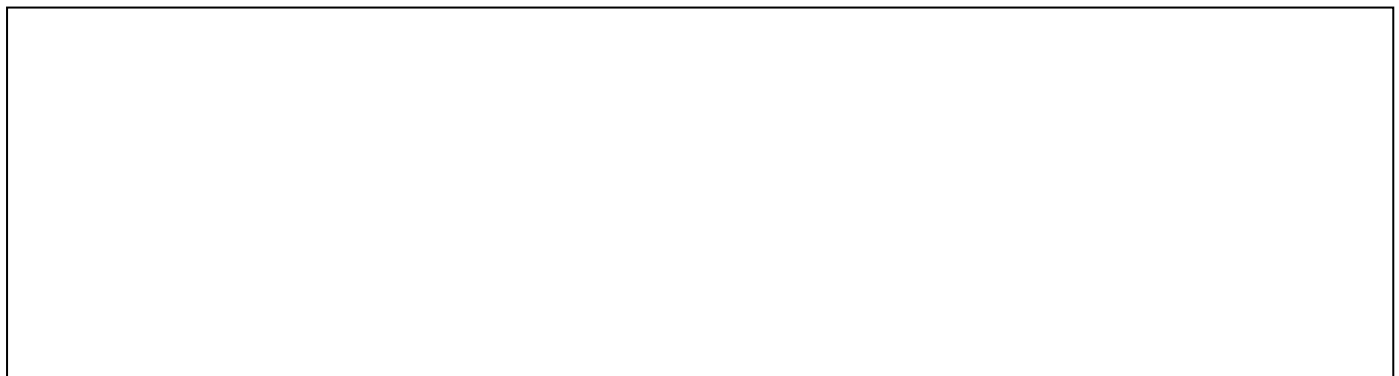

Fig.2-5 Cardboard Box



2.4 Reliability Test Items And Conditions

Table 2-3 Reliability Test Items And Conditions

Test Items	Ref.Standard	Test Condition	Time	Quantity	Ac/Re /
Reflow	JESD22-B106	Temp:260 max T=10 sec	2times	20pcs.	0/1
MSL2 2	JESD22-A113	85 / 60%RH	168 hrs.	20pcs.	0/1
Thermal Shock	JEITAED-4701 300307	-40 15min 10s 125 15min	1000 cycle	20pcs.	0/1
Life Test	JESD22-A108	Ta=100 If=5mA	1000hrs.	20pcs.	0/1
High Temperature High Humidity Life Test	JESD22-A101	85 / 85%RH If=5mA	1000hrs.	20pcs.	0/1



2.5 Criteria For Judging Damage

Table 2-4 Criteria For Judging Damage

Test Items	Symbol	Test Condition	Criteria For Judgement	
			Min.	Max.
Forward Voltage	V_F	$I_F=5mA$	-	U.S.L*)x1.1
Reverse Current	I_R	$V_R = 5V$	-	U.S.L*)x2.0
Luminous Flux		$I_F=5mA$	L.S.L*)x0.7	-

Notes

1.U.S.L: Upper standard level

L.S.L: Lower standard level

2.The above reliability tests is based on the verification of a single/strip LED of Refond's existing experimental platform,the reliability experiment was taken under good heat dissipation conditions. when customers applies the LTw 27(-16nd [(cu)-11(st)-5Tc 0 T01>Tj 1.114 0 Td <931E52f)Tj 0 Tc 0 Tw 0.75 0 Td ()Tj Tc 0.011 T5029(3(as



3. SMT Reflow Soldering Instructions SMT 回流焊说明

3.1 SMT Reflow Soldering Instructions SMT

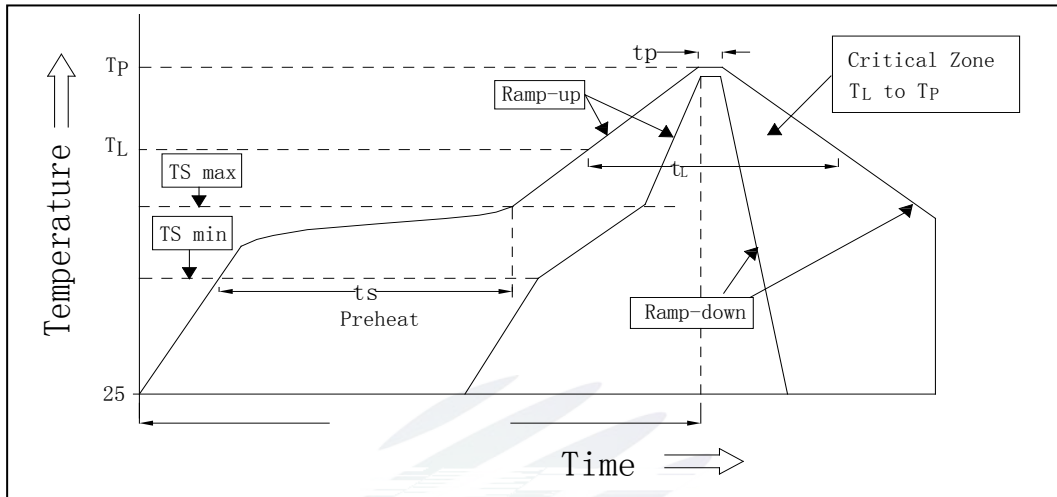
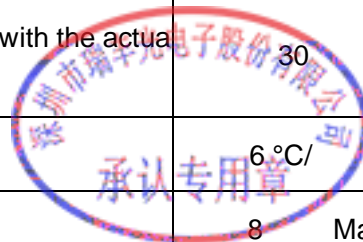

Fig.3-1 SMT Reflow Soldering Instructions SMT

Table 3-1 Reflow parameters

Average temperature rise speed	$T_{smax} - T_P$	3 °C/ s	Max 3 °C/ s
Preheating: minimum temperature	(T_{smin})	150 °C	
Preheating: Max temperature	(T_{smax})	200 °C	
Preheating: Time	$T_{smin} - T_{smax}$	60 - 120	60s-120s
Time limited to maintain high temperature: the temperature	(T_L)	217 °C	
Time limited to maintain high temperature: The Time	(t_L)	60	Max 60s
Peak /Classification of temperature:	(T_P)	260 °C	
Time limit classification of peak temperature time	t_p	10	Max 10s
peak temperature (TP)	5 °C	Hold time within 5 °C with the actual peak temperature (TP)	30 Max 30s
Cooling speed		6 °C/ s	Max 6 °C/ s
25 °C	Needed time from 25 °C to T_p	8	Max 8 minutes





Notes

(1)Reflow soldering should not be done more than twice. If more than 24 hours between the two solderings , LED will be damaged. 24 LED

(2)When soldering , do not put stress on the LEDs during heating.

3.1.1 Soldering Iron

(1) When do soldering by hand, keep the temperature of iron belowless 300 less than 3 seconds. 300 3

(2) Soldering by hand should be done only one time.

3.1.2 Repairing

Repairing should not be done after the LEDs have been soldered. When repairing is unavoidable,a double-head soldering iron should be used (as below figure). It should be confirmed in advance whether the characteristics of LEDs will or not be damaged by repairing.

LED

LED

3.1.3 Cautions

(1) The encapsulated material of the LEDs is silicone. Therefore the LEDs have a soft surface on the top of package. The pressure to the top surface will be impacted on the reliability of the LEDs. Precautions should be taken to avoid the strong pressure on the encapsulated part. So when use the picking up nozzle, the pressure on the silicone resin should be proper. LED LED

(2) Components should not be mounted on warped (non coplanar) portion of PCB. After soldering, do not warp the circuit board.LED PCB

(3) Do not apply mechanical force or excess vibration during the cooling process to normal temperature after soldering. Do not rapidly cool device after soldering.





4. Handling Precautions

4.1 Handling Precautions

(1) LED operating environment and sulfur element composition cannot be over 100PPM in the LED mating usage material. This is provided for informational purposes only and is not a warranty or endorsement.

LED 100PPM

(2) In order to prevent external material from getting into the inside of LED, which may cause the malfunction of LED, the single content of Bromine element is required to be less than 900PPM, the single content of Chlorine element is required to be less than 900PPM, the total content of Bromine element and Chlorine element in the external materials of the application products is required to be less than 1500PPM. This is provided for informational purposes only and is not a warranty or endorsement.

LED LED 900PPM
900PPM 1500PPM

(3) VOCs (Volatile organic compounds) emitted from materials used in the construction of fixtures can penetrate silicone encapsulants of LEDs and discolor when exposed to heat and photonic energy. The result can be a significant loss of light output from the fixture. Knowledge of the properties of the materials selected to be used in the products is required.



Fig 4-1 Handling Precautions

(5) In designing a circuit, the current through each LED can not exceed the absolute maximum rating specified for each LED. In the mean while, resistors for protection should be applied, otherwise slight voltage shift will cause big current change, burn out may happen. The driving circuit must be designed to allow forward voltage only when it is ON or OFF. If the reverse voltage is applied to LED, migration can be generated resulting in LED damage.

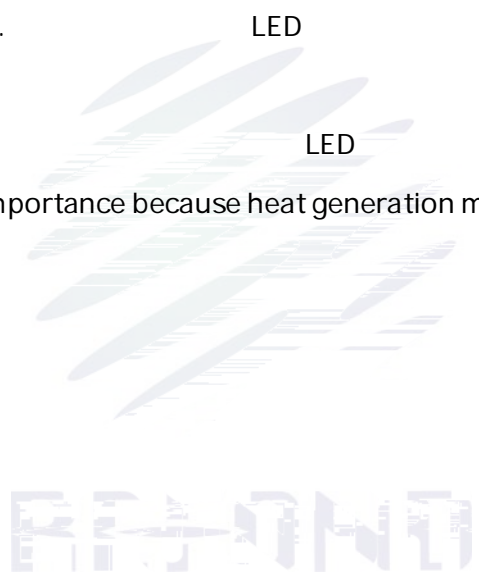

(6) Thermal Design is paramount importance because heat generation may result in the Characteristics

/

(6) Thermal Design is paramount importance because heat generation may result in the Characteristics



Table 4-1 Storage

Conditions		Temperature	Humidity	Time
Storage	Before Opening Aluminum Bag	30	75%	Within 1 Year From Date
	After Opening Aluminum Bag	30	60%	Recommended for use within 24 hours 24
Baking		60± 5	-	24hours 24

(8) If the moisture absorbent material silica gel has faded away or the LEDs have exceeded the storage time, baking treatment should be performed after unpacking and based on the following condition 60± 5 for above 24 hours.

60± 5 24

If the package is flatulence or damaged, please notify the sales staff to assist.

(9) Similar to most Solid state devices; LEDs are sensitive to Electro-Static Discharge (ESD) and Electrical Over Stress (EOS).
LED

(10) Other points for attention, please refer to our relevant information.





REFOND



Declare

This specification is written both in English and in Chinese and the latter is formal.