

1.

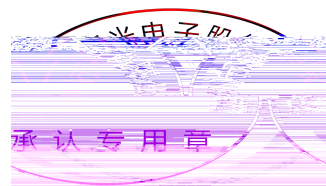

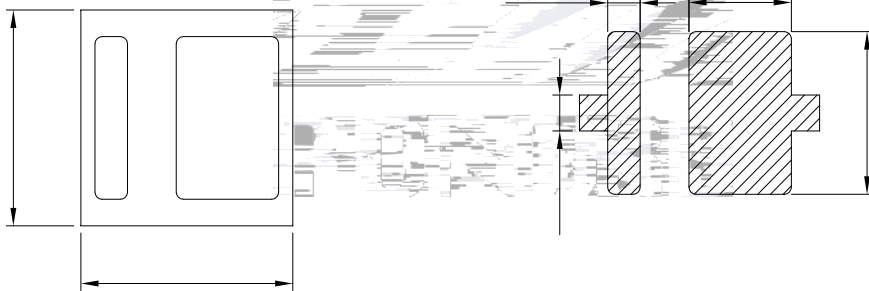

±

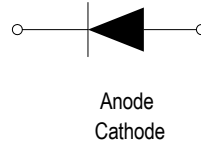
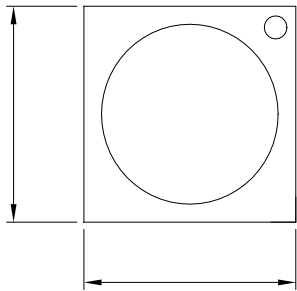
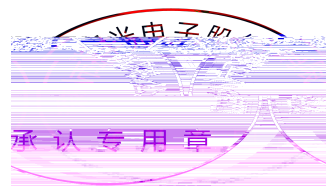

| | | | | | | |
|--|-----------|--|--|--|--|--|
| | | | | | | |
| | | | | | | |
| | | | | | | |
| | λ | | | | | |
| | | | | | | |
| | | | | | | |
| | | | | | | |
| | | | | | | |

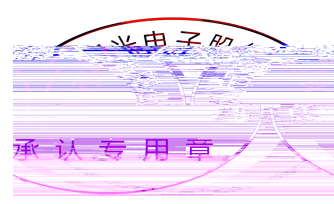



瑞豐光電



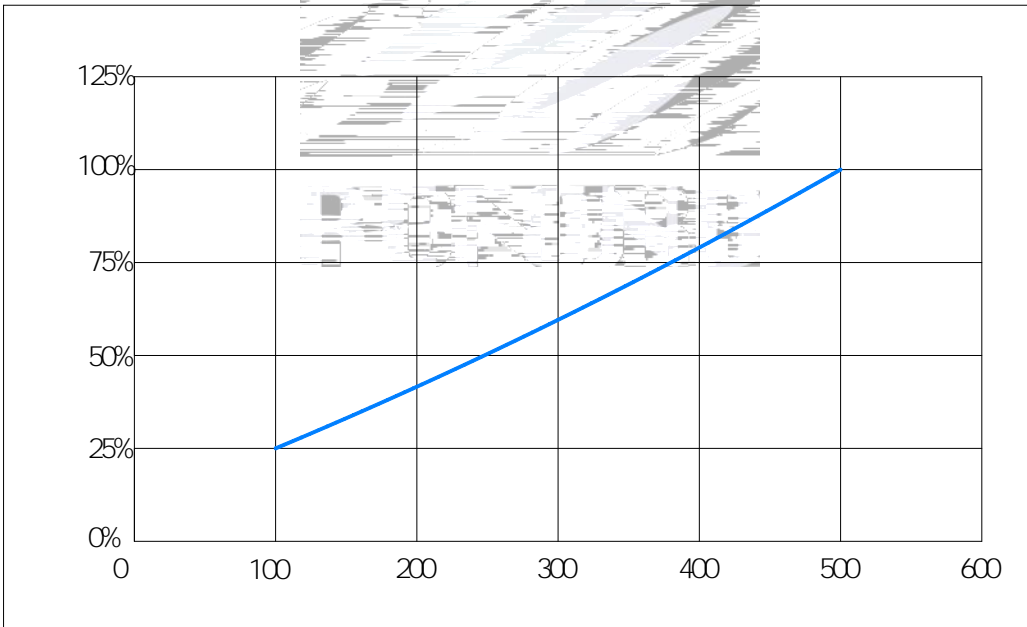
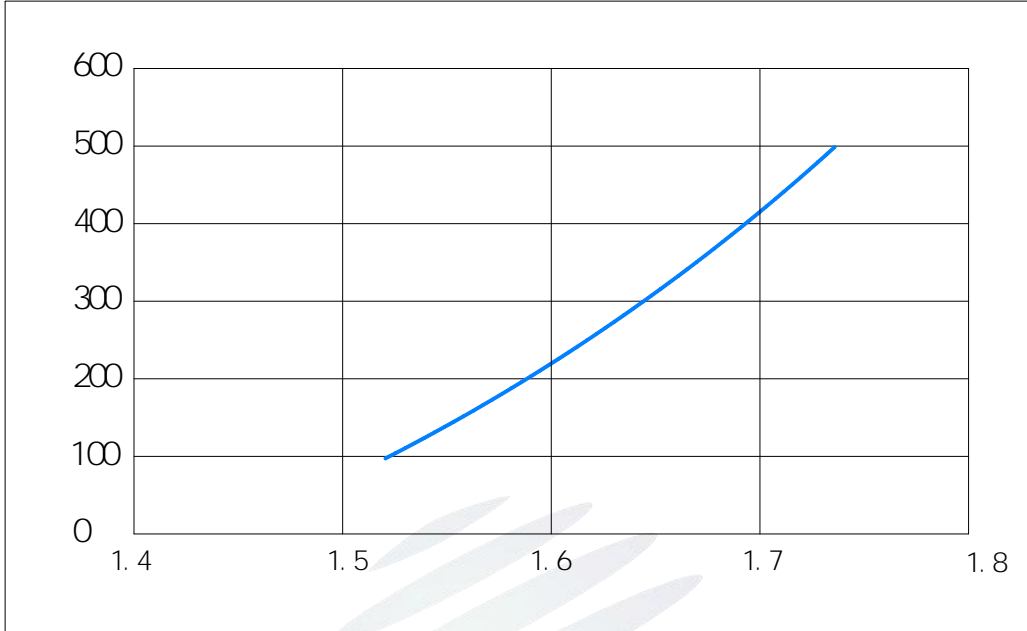

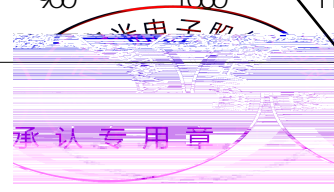
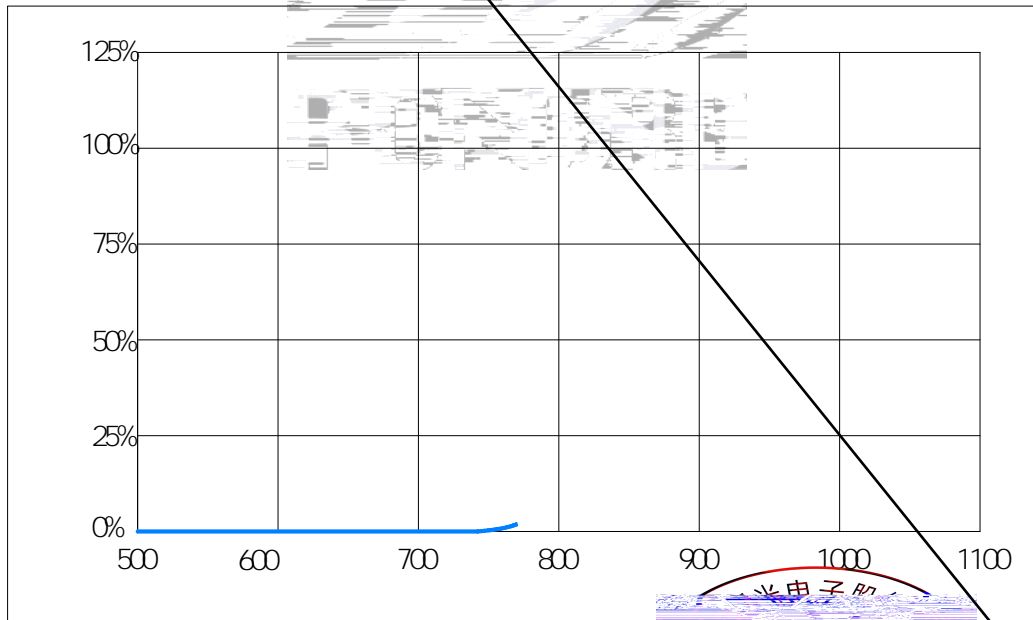
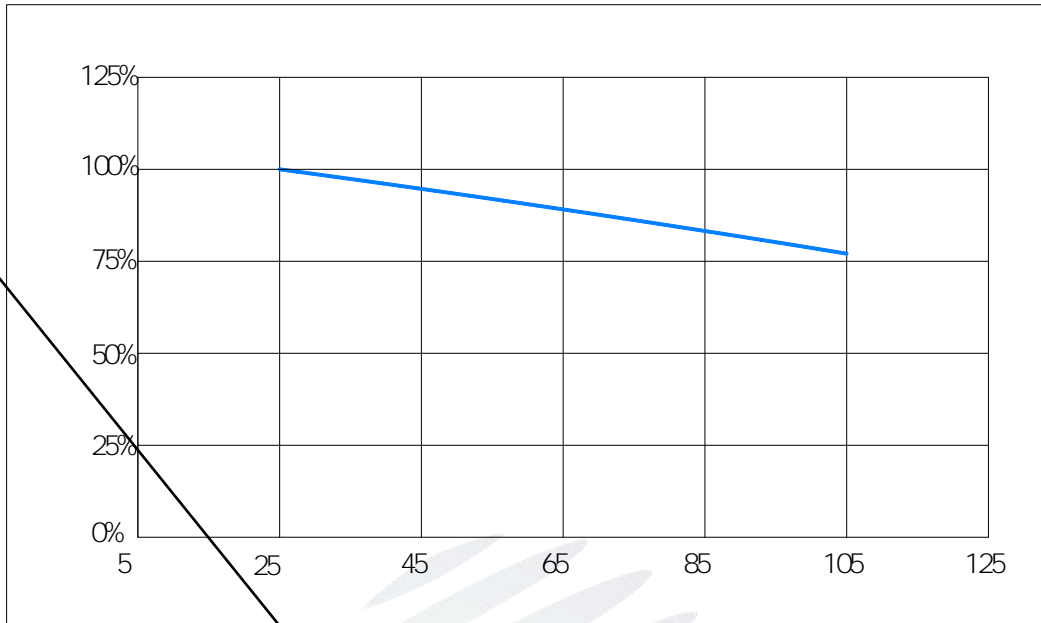

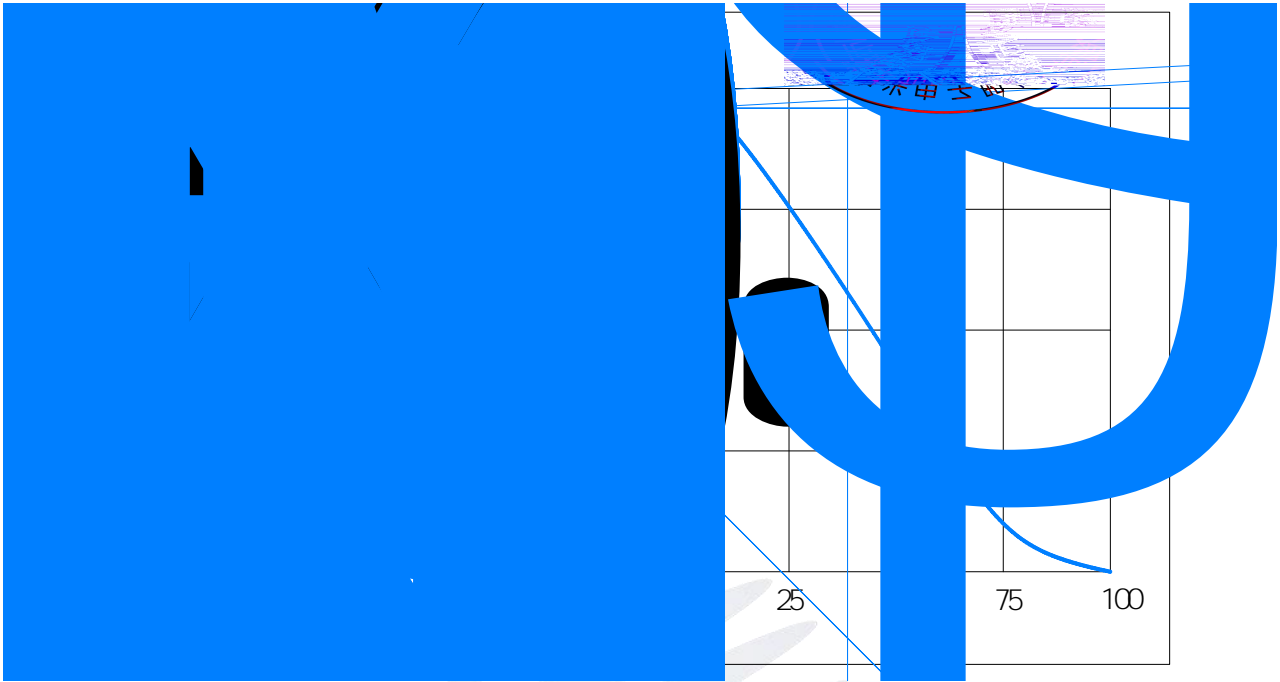

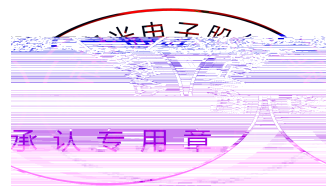
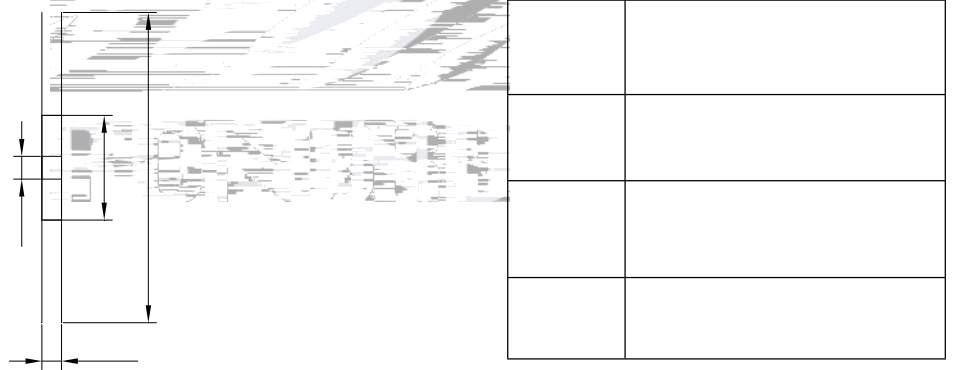
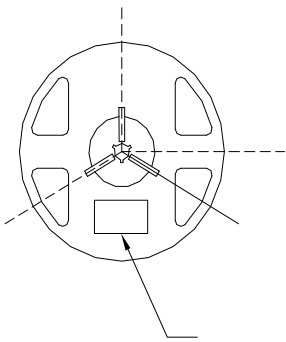
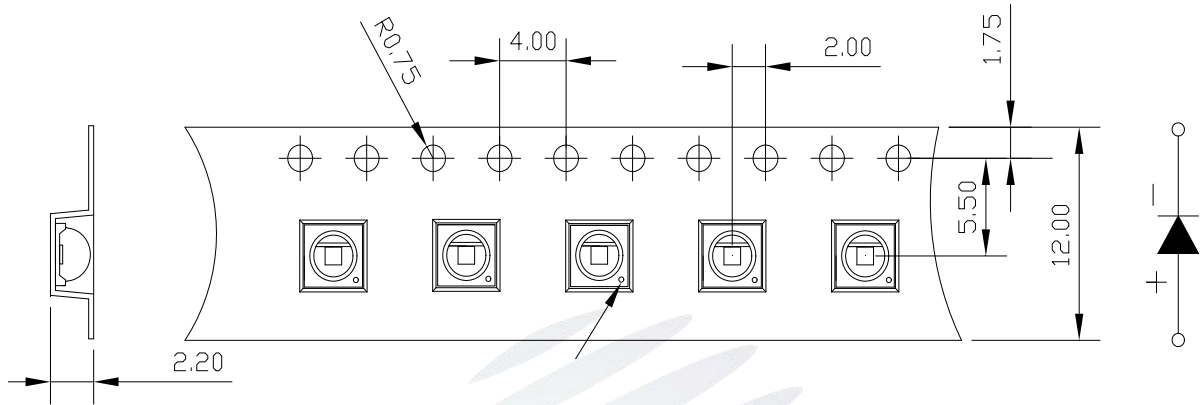

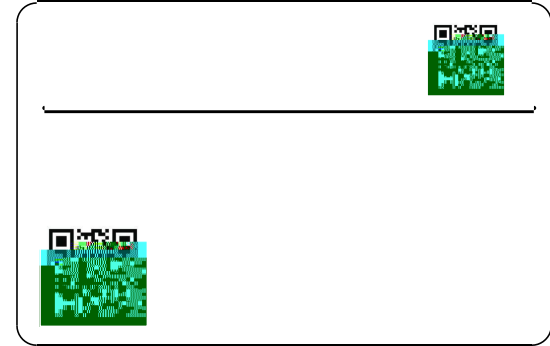

Seven horizontal lines for text entry.

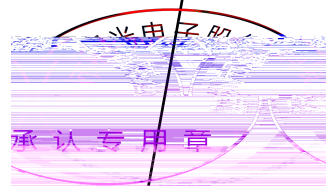
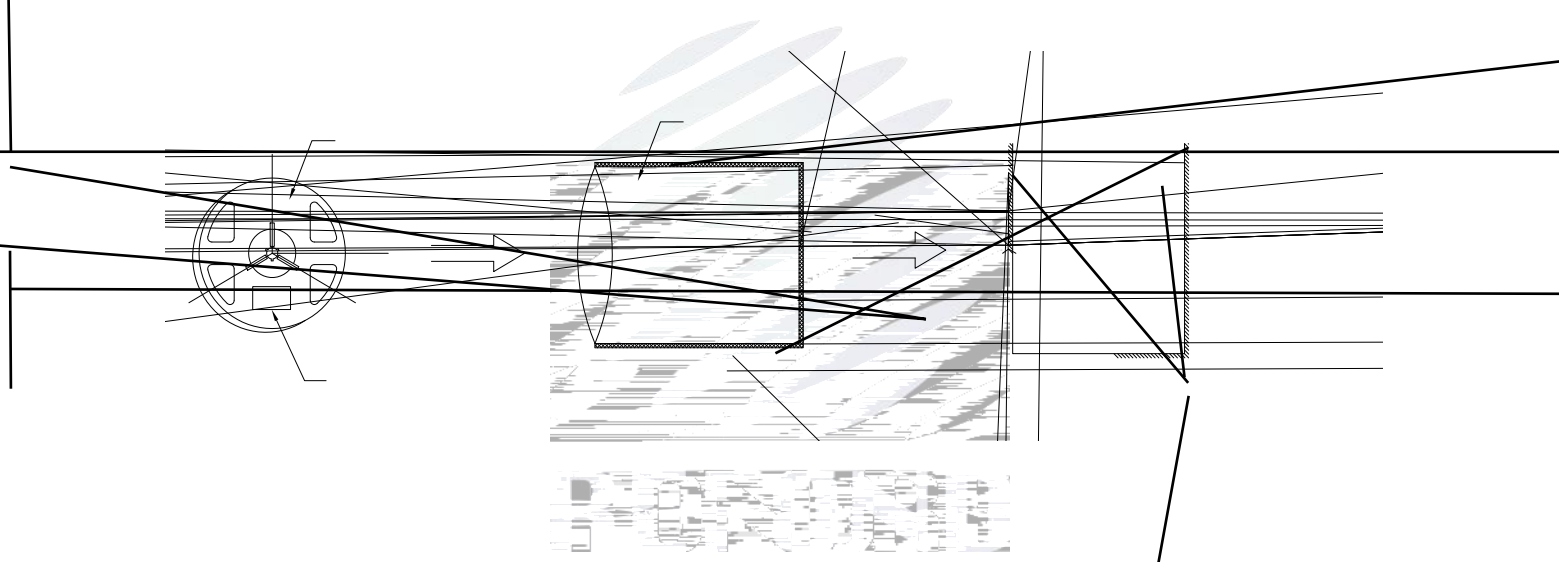

| | | | | |
|--|--|--|--|--|
| | | | | |
| | | | | |
| | | | | |
| | | | | |



1.





瑞豐光電



°C

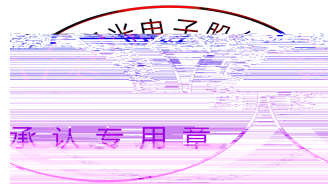

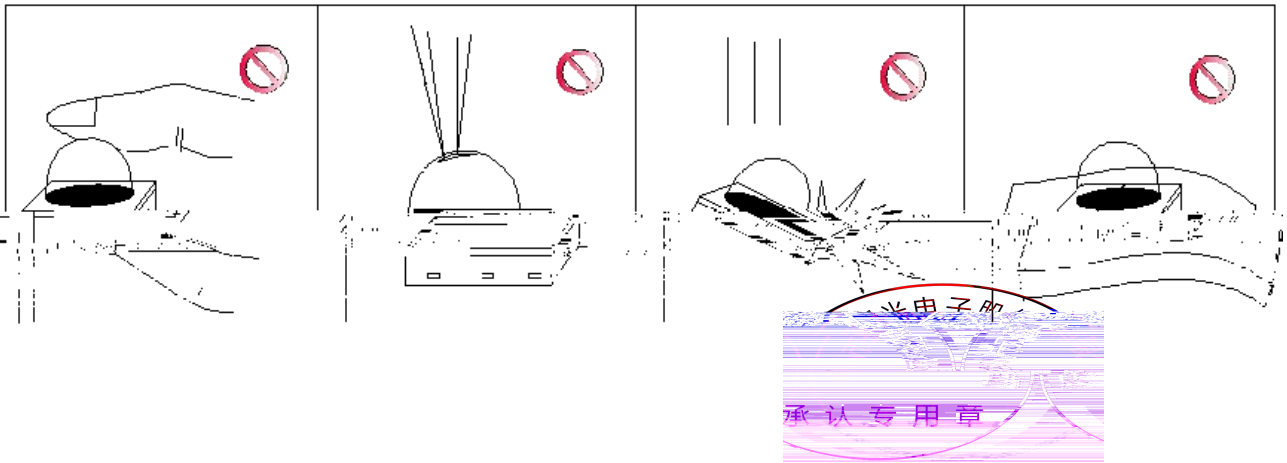

(7) () (±) °C

