

SPECIFICATION

产品规格书

REFOND P/N 产品型号

RF-W1SA35IS-A42

R&D 研发

Mass Product 量产供货

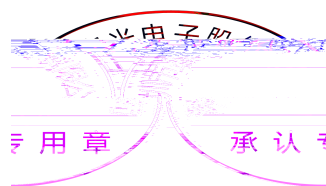

Contents 目錄

1. Description 产品介绍	
1.1 General Description 产品描述	
1.2 Features 产品特征	
1.3 Application 产品应用	
1.4 Package Dimension 封装尺寸	
1.5 Product Parameters 产品参数	
1.6 Typical optical characteristics curves 典型光学特性曲线	
2. Packaging 产品包装	
2.1 Packaging Specification 包装规格	
2.1.1 Carrier Tape Dimension 载带尺寸	11
2.1.2 Reel Dimension 卷盘尺寸	11
2.1.3 Label Form Specification 标签规格	12
2.2 Moisture Resistant Packing 防潮包装	
2.3 Cardboard Box 包装纸箱	
2.4 Reliability Test Items And Conditions 信赖性测试项目及条件	
2.5 Criteria For Judging Damage 失效判定标准	
3. SMT Reflow Soldering Instructions SMT 回流焊说明	
3.1 SMT Reflow Soldering Instructions SMT 回流焊说明	
3.1.1 Soldering Iron 烙铁焊接	17
3.1.2 Repairing 维修	17
3.1.3 Cleaning 清洗	17
4. Handling Precautions 产品使用注意事项	
4.1 Handling Precautions 产品使用注意事项	
4.1.1 Storage 贮存	18
4.1.2 Static Electricity 静电	18
4.1.3 Reverse voltage protection 反压保护	19
4.1.4 The safe temperature for LEDs working 温度保护	19

4.1.5 Others 其它事项20

4.1.6 Declare 申明.....20

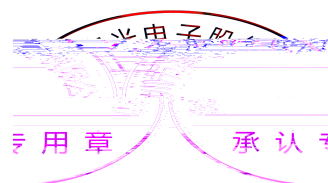

1. Description 产品介绍

1.1 产品描述

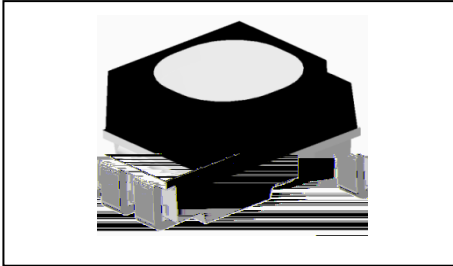

The product is a full-color LED device, High contrast(Surface brush design). The product size: 3.7mmX3.5mmX2.8mm.

该产品为全彩 LED 器件，高对比度(表面刷墨设计)，产品尺寸: 3.7mmX3.5mmX2.8mm。

1.2 Features 产品特征

Surface not reflective. 表面不反光

High luminous Intensity, Low power dissipation, Good reliability and Long life.

光强高、功耗低、可靠性好、寿命长

Water-resistant(IPX6): 防水等级(IPX6)

Moisture sensitivity level: 5a 潮湿敏感等级:5a

RoHS compliant. 满足RoHS要求

Matte surface. 哑光表面

Pb-free reflow soldering application. 无铅回流焊

1.3 Application 产品应用

Outdoor full-color video screen. 户外全彩显示屏

The automobile dashboard. 汽车仪表盘

Indoor and outdoor decorative lighting. 室内外装饰照明

Amusement. 娱乐产品

General use. 其他应用

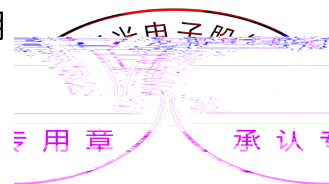

1.4 Package Dimension 封装尺寸

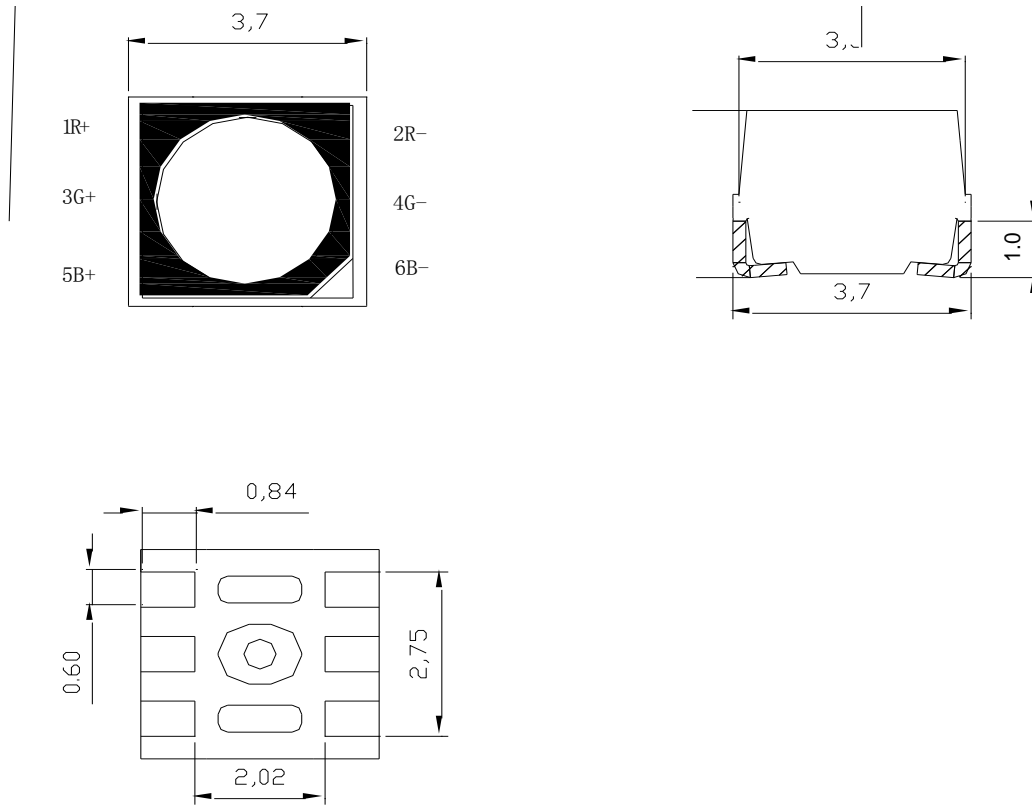

Notes 备注:

1. All dimensions units are millimeters. 所有尺寸标注单位为毫米
2. All dimensions tolerances are 0.1mm unless otherwise noted. 除特别标注外, 所有尺寸公差为±0.1 毫米

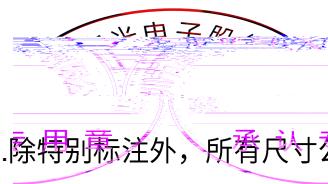

1.5 Product Parameters 产品参数

Table 1-1 Electrical / Optical Characteristics at Ts=25°C 电性与光学特性

Item 项目	Symbol 符号	Test Condition 测试条件	Value			Unit 单位
			R	G	B	
Reverse Current (漏电流)	I_R	$V_R=5V$	6	6	6	
Forward Voltage (正向电压)	$V_F(\min)$	R $I_F = 20mA$ G $I_F = 20mA$ B $I_F = 20mA$	1.7	2.7	2.7	V
	$V_F(\max)$		2.4	3.4	3.4	V
Dominant Wavelength 主波长	D		618~628	518~530	464~474	nm
Spectrum Radiation Bandwidth 半波宽			24	38	30	nm
Luminous Intensity 光强	$I_V(\min)$		770	1615	400	mcd
	$I_V(\text{avg})$		1000	2100	520	mcd
Viewing Angle (发光角度)			110			deg

Table 1-2 Absolute Maximum Ratings at Ts=25°C 绝对最大值

Parameter (参数)	Symbol (符号)	Rating (值)			Unit 单位
		R	G	B	
Forward Current (正向电流)	I_F	25	20	20	mA
Peak Forward Current (峰值电流)	I_{FP}	80	80	80	mA
Reverse Voltage (反向电压)	V_R	5	5	5	V
Operating Temperature (操作温度)	T_{OPR}	-30 ~ +85			
Storage Temperature (储存温度)	T_{STQ}	-40 ~ +100			
Power Dissipation (功耗)	P_D	60	68	68	mW
Electrostatic Discharge (HBM) (静电)	E_{SD}	1000V			

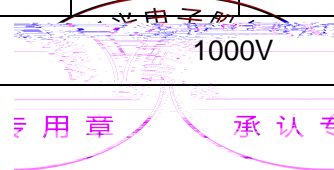

Notes 备注:

1. 1/10 Duty cycle, 0.1ms pulse width. 脉宽0.1ms,占空比1/10.
2. The above forward voltage measurement allowance tolerance is $\pm 0.05V$. 以上所示电压测量误差 $\pm 0.05V$.
3. The above Tolerance of measurement of dominant wavelength $\pm 1nm$. 以上所示波长测量公差 $\pm 1nm$.
4. The above luminous intensity measurement allowance tolerance $\pm 10\%$. 上述发光强度的测试允许公差为 $\pm 10\%$
5. Care is to be taken that power dissipation does not exceed the absolute maximum rating of the product. 使用功率不能超过规定的最大值。
6. All measurements were made under the standardized environment of Refond. 本现有的所有测试都是基于瑞丰标准测试平台。
7. All the datas are just for reference, specific parameters please refer to the label. 以上参数仅供参考,请以实物标签为准。

1.6 Typical optical characteristics curves 典型光学特性曲线

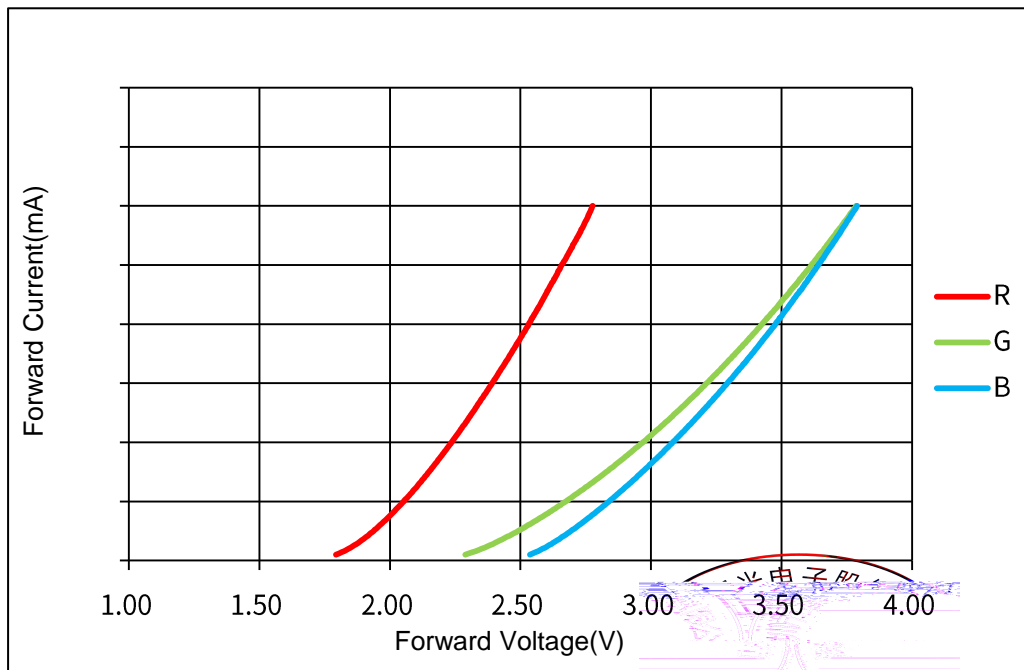

Fig 1-6 Forward Voltage Vs. Forward Current 伏安特性曲线

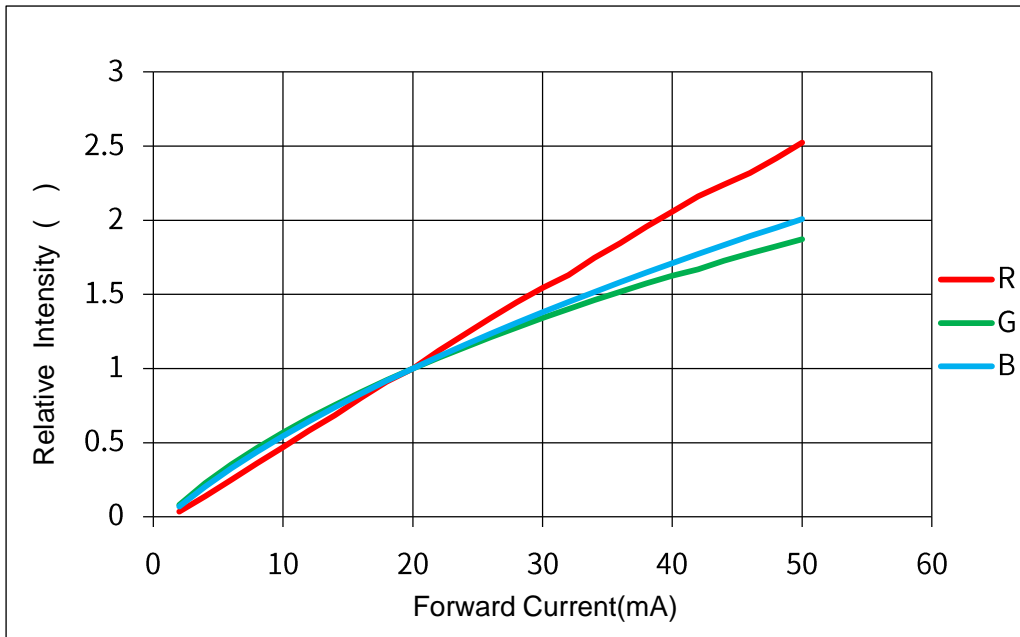

Fig 1-7 Forward Current Vs. Relative Intensity 正向电流与相对光强特性曲线

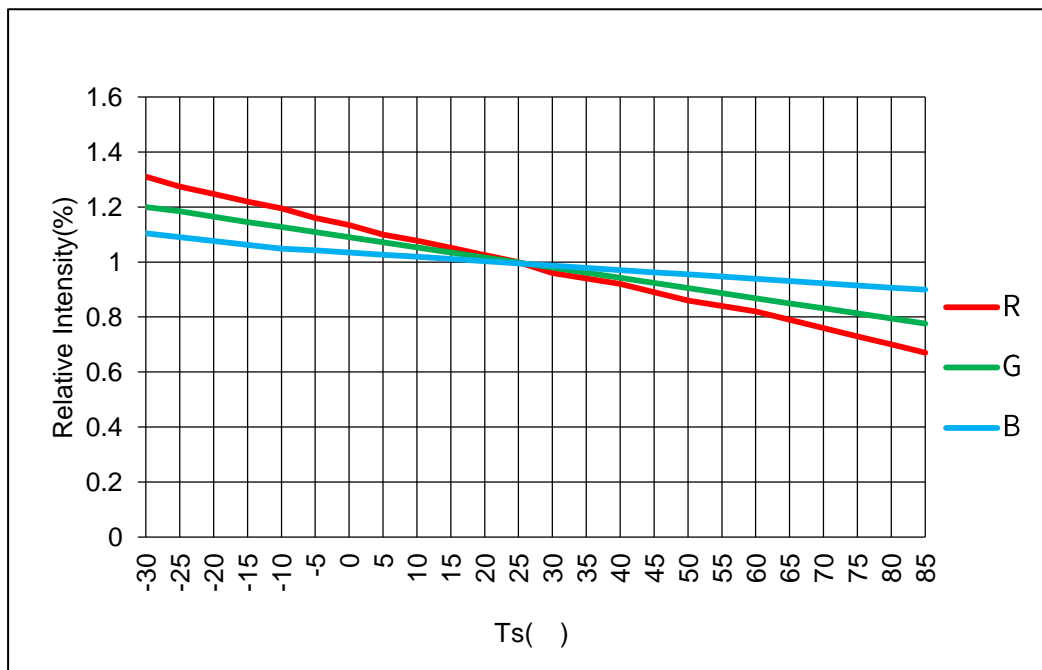

Fig 1-8 Luminous Intensity VS Ambient Temperature 光强与环境温度曲线

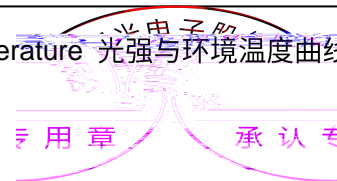

Fig 1-9 Solder Temperature Vs Forward Current



Fig 1-10 Spectrum Distribution 光谱分布特性曲线

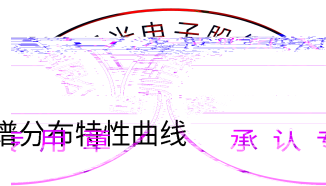
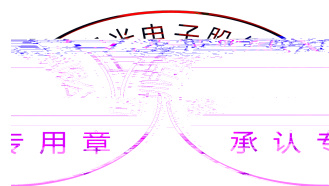

Fig 1-11 Directivity X-X radiation angle X轴方向輻射角度

Fig 1-12 Directivity Y-Y radiation angle Y轴方向輻射角度



2.1.3 Label Form Specification 标签规格

Table 2-2 Title 表名

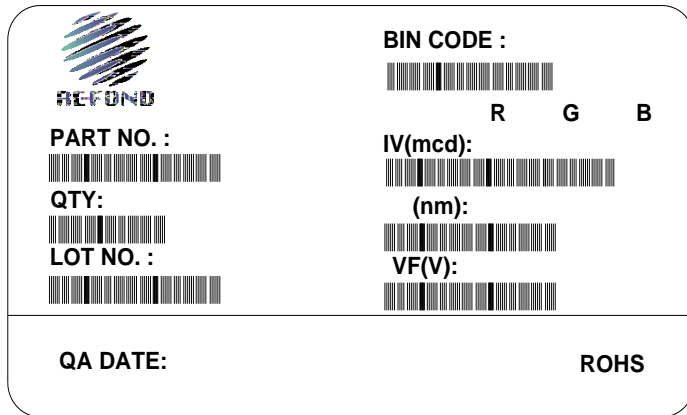

PART NO.	Part Number	品名
LOT NO.	Lot Number	批次号
BIN CODE	Bin Code	参数代码
IV	Llight intensity	光强
VF	Forward Voltage	正向电压
D	Wavelength	波长代码
QTY	Packing Quantity	数量
DATE	Made Date	生产日期

Fig 2-3 Title 图名

2.2 Moisture Resistant Packing 防潮包装

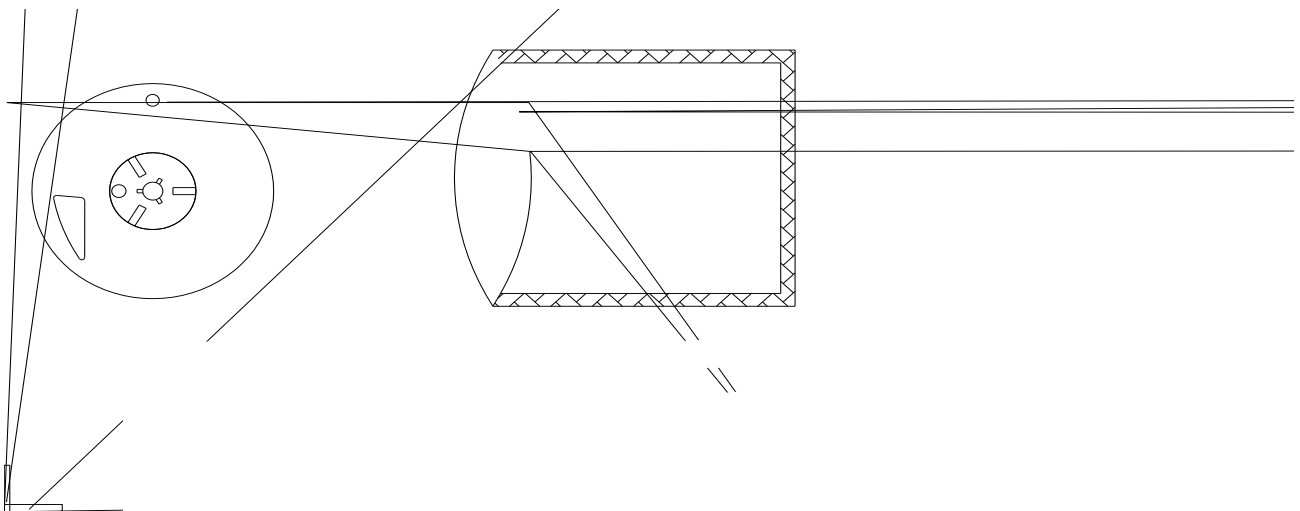
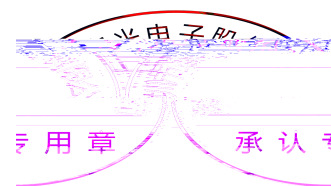

Fig.2-4 Title 图名



2.3 Cardboard Box 包装纸箱

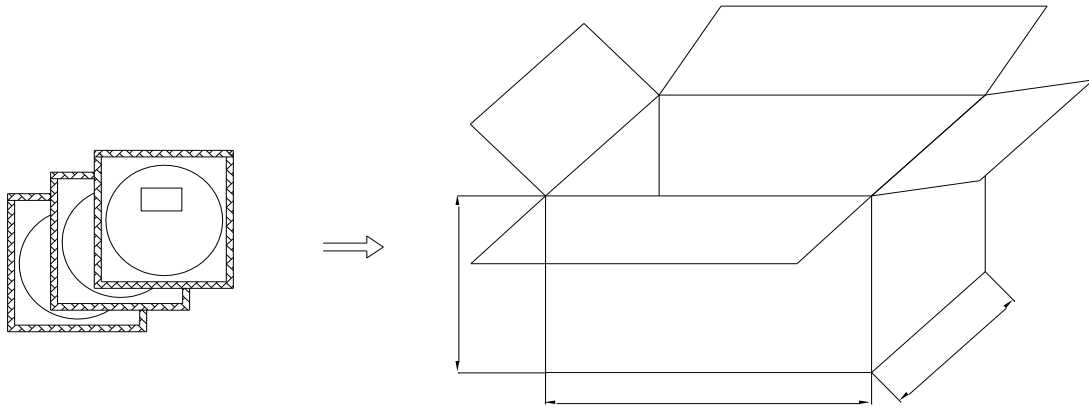

Fig.2-5 Title 图名

2.4 Reliability Test Items And Conditions 信赖性测试项目及条件

Table 2-3 Title 表名

Test Items 项目	Ref.Standard 参考标准	Test Condition 测试条件	Time 时间	Quantity 数量	Ac/Re 接收/拒收
Resistance to Soldering Heat 耐焊接热	JESD22-B106	Temp:260°Cmax T=10 sec			

Room Temperature Operating Life 常温寿命测试	JESD22-A108	$T_A=25^{\circ}\text{C}$ $I_F=20\text{mA}$	1000hrs.	22pcs.	0/1
High Temperature High Humidity Life Test 高温高湿寿命测试	JESD22-A101	$85^{\circ}\text{C}/85\%\text{RH}$ $I_F=15\text{mA}$	500hrs.	22pcs.	0/1
Temperature Humidity Storage 高温高湿储存	JEITA ED-4701 100 103	$T_A=85^{\circ}\text{C}$ $\text{RH}=85\%$	1000hrs.	22pcs.	0/1
Low Temperature Life Test 低温寿命	JESD22-A108D	$T_A=-40^{\circ}\text{C}$, $I_F=20\text{mA}$	1000hrs.	22pcs.	0/1

2.5 Criteria For Judging Damage 失效判定标准

Table 2-4 Title 表名

Test Items 项目	Symbol 符号	Test Condition 测试条件	Criteria For Judgement 判定标准
Forward Voltage 正向电压	V_F	$I_F=20\text{mA}$	Initial Data $\pm 10\%$ 初始值 $\pm 10\%$
Reverse Current 反向电流	I_R	$V_R = 5\text{V}$	I_R
Luminous Intensity 光强	I_V	$I_F=20\text{mA}$	Average I_V degradation rate 平均 I_V 衰减 $\leq 30\%$
Resistance to Soldering Heat 耐焊接热	/	/	No internal cracks, no material between stripped, no deaded light 材料无内部裂痕、剥离、无死灯

Table 3-1 Title 表名

Average temperature rise speed平均升温速度 (T _{max} 至T _P)	Max 4 °C/ s 最高4 °C/秒
Preheating: minimum temperature预热：最低温度 (T _{min})	150 °C
Preheating: Max temperature预热：最高温度 (T _{max})	200 °C
Preheating: Time预热：时间 (T _{min} 至T _{max})	60s-120s 60 - 120秒

Time limited to maintain high temperature: the temperature

限时维持高温：温度 (T

3.1.1 Soldering Iron 烙铁焊接

(1) When hand soldering, keep the temperature of iron below less 300°C less than 3 seconds
当手工焊接时，烙铁的温度必须小于300°C，时间不可超过3秒。

(2) The hand solder should be done only one time.手工焊接只可焊接一次。

3.1.2 Repairing 维修

Repair should not be done after the LEDs have been soldered. When repairing is unavoidable, a double-head soldering iron should be used (as below figure). It should be confirmed in advance whether the characteristics of LEDs will or will not be damaged by repairing.

LED回流焊后不应该修复，当必须修复时，必须使用双头烙铁，而且事先应确认此种方式会不会损坏LED本身的特性。

3.1.3 Cleaning 清洗

Try to use "no clean solder paste type", so, after reflow need not cleaning. If you need to clean the PCB, after the completion of welding recommended the use of isopropyl alcohol (IPA) cleaning. When using other solvents, it should be confirmed beforehand the solvents do not damage the LED. Do not use ultrasonic cleaning.

尽量使用“免清洗型”焊锡膏，这样，在回流焊后就不需要清洗焊剂。如果需要清洁PCB,焊接完成后推荐使用异丙醇(IPA)进行清洗。使用其它类似溶剂清洗前,请先确认使用的溶剂不会对LED造成损伤.不推荐使用超声波清洗。

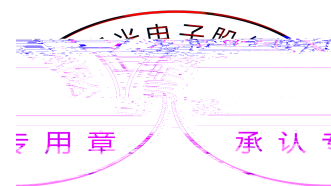

4.Handling Precautions 产品使用注意事项

4.1 Handling Precautions 产品使用注意事项

4.1.1 Storage 贮存

(1) Moisture proof and anti-electrostatic package with moisture absorbent material is used, Packaged products have one year to save time.

本产品使用密封防潮抗静电袋包装,并附有干燥剂,未开封的产品保存时间一年。

(2) Before opening the package, the product should be kept at 30 or less and humidity less than 60%RH.

开封前,产品须存放在温度不高于30°C,湿度不高于60%RH的环境中。

(3) Seal anti-electrostatic bag humidity card should immediately check bag humidity indicator card in the open the bag after, Humidity is greater than or equal to 30%, Must be baked before use
密封防静电袋内的湿度卡应在打开袋子后立即查看袋内的湿度指示卡来确定,湿度显示大于或等于30%时,使用前须进行烘烤。

(4) After opening the package, the product should be soldered within 24 hours. If not, please store at 30 or less and humidity less than 10%RH. It is recommended that the product be operated at the workshop condition of 30 or less and humidity less than 60%RH.

开封后,产品必须24小时内使用完(建议工作环境温度不高于30°C,湿度不高于60%),如未使用完,余料须存放在温度不高于30°C,湿度不高于10%的环境中。

(5) If the moisture absorbent material has fade away or the LEDs have exceeded the storage time, baking treatment should be performed based on the following condition : 65±5°C for 24 hours.

对于尚未焊接的LED,如果吸湿剂或包装失效,或者产品没有符合以上有效存储条件,烘烤可以起到一定的性能恢复效果,烘烤条件:65±5 ,持续时间24H。

4.1.2 Static Electricity 静电

(1) The following procedures may decrease the possibility of ESD damage.

以下操作可降低静电破坏的可能性

(2) Minimize friction between the product and surroundings to avoid static buildup.

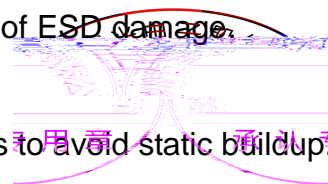

将产品和外界之间的摩擦减到最低以避免静电产生。

(3) All production machinery and test instruments must be electrically grounded.

所有的产品设备和测试仪器必须接地。

(4) Operators must wear anti-static bracelets.

操作人员必须配戴静电环。

(5) Wear anti-static suit when entering work areas with conductive machinery.

进入带电设备工作区时须穿防静电服。

(6) All workstations that handle IC and ESD-sensitive components must maintain an electrostatic potential of 150V or less.

所有操作 IC 和 ESD 敏感器件的工作台必须保持低于 150V 的静电保护。

4.1.3 Reverse voltage protection 反压保护

In generally the reverse current of LED is very small, it can't effect using the component normally, but when it often suffered the reverse voltage which exceed the limits of the component than it will be damaged, the reverse current increases rapidly causing the string light display gray scale so when designing, please pay attention to control the reverse voltage we suggest the reverse voltage less than 10V.

通常 LED 的反向漏电流都会很小,不会影响正常使用. 如果长期遭受超过其所能承受的反向电压冲击时,LED 会损伤,反向漏电流会迅速变大,引起显示屏零灰度下串光的发生. 在设计中,要注意控制反向电压,建议加在 LED 上的反向电压值不超过 10V.

4.1.4 The safe temperature for LEDs working 温度保护

Luminous Intensity deceased radically, if LEDs worked in hot environment for a long time, they will be disabled easily. When LEDs are working in a closed surface temperature should be lower than 55 temperature should be lower than 75 .

LED 在高温条件下,衰减会加速,使用寿命也会若长期处于高温环境下,极容易出现失效. 对于高密度排列使用的情况,建议在使用过程中灯面温度不超过 55°C,灯脚温度不超过 75°C.

用章 承认

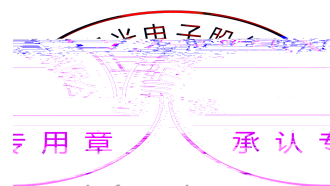

Declare 申明

This specification is written both in English and in Chinese and the latter is formal.

产品规格书以中英文方式书写，若有冲突以中文版本为准。