

SPECIFICATION

LT P/N

LT264WH-A-GL

Mass Product

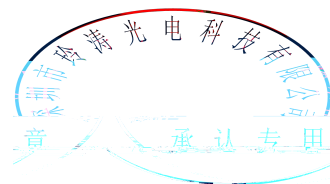

Contents

1. Description	3
1.1 General Description	3
1.2 Features	3
1.3 Application	3
1.4 Package Dimension	4
1.5 Product Parameters	4
1.6 Bin Range Of Forward Voltage and Luminous Intensity (IF=20mA)	BIN
(IF=20mA)	6
1.7 Typical Optical Characteristics Curves	6
2. Packaging	10
2.1 Packaging Specification	10
2.1.1 Carrier Tape Dimension	10
2.1.2 Reel Dimension	12
2.1.3 Label Form Specification	11
2.2 Moisture Resistant Packing	11
2.3 Cardboard Box	11
2.4 Reliability Test Items And Conditions	11
2.5 Criteria For Judging Damage	12
3. SMT Reflow Soldering Instructions SMT	13
3.1 SMT Reflow Soldering Instructions SMT	13
4. Handling Precautions	15
4.1 Handling Precautions	15

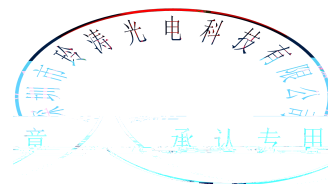

1. Description

1.1



The White LED, which was fabricated by using a blue chip and the phosphor.

Product Package: 2.6mmX0.6mmX0.4mm.

1.2 Features

PLCC Package. PLCC

Wide viewing angle.

Suitable for all SMT assembly and solder process.

Available on tape and reel.

Moisture sensitivity level: Level 3.

RoHS compliant.

1.3 Application

LCD Back Light. LCD

Mobile Phones.

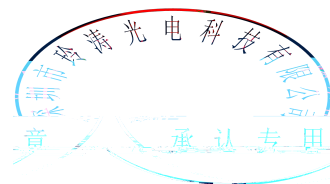

1.4 Package Dimension

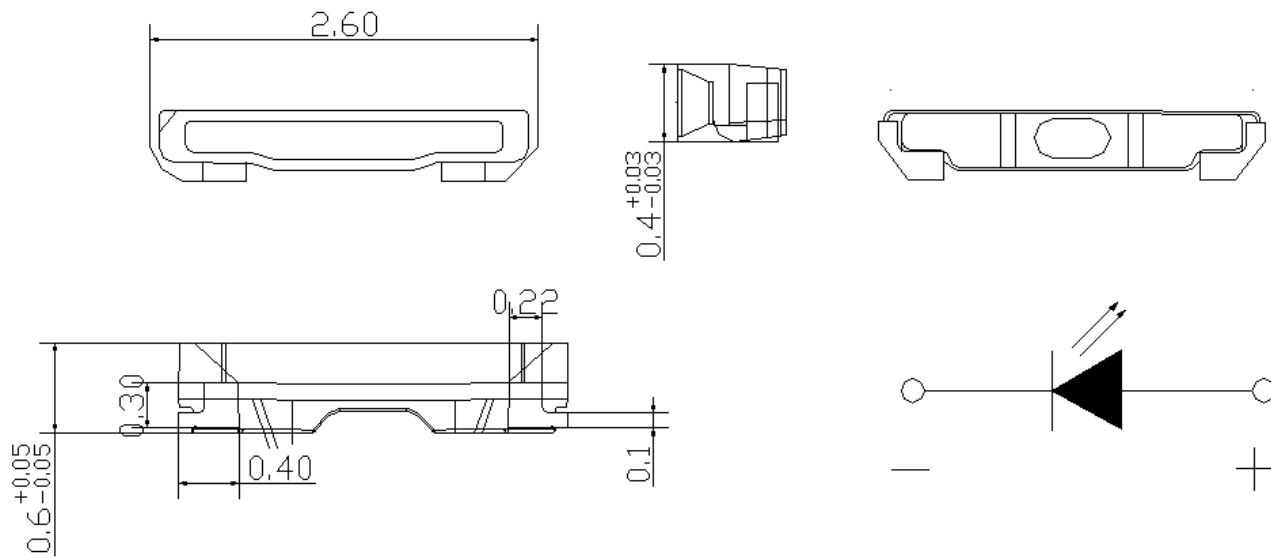

Notes

All dimensions units are millimeters

All dimensions tolerances are ± 0.1 mm unless otherwise noted.

±

1.5 Product Parameters

Table 1-1 Electrical / Optical Characteristics at $T_s=25^\circ\text{C}$

Item	Symbol	Test Condition	Value			Unit
			Min.	Typ.	Max.	
Forward Voltage	V_F	$I_F=20\text{mA}$	---	2.8	---	V
Reverse Current	I_R	$V_R=5\text{V}$	---	---	1	μA
Luminous Intensity	I_v	$I_F=20\text{mA}$	---	2650	---	mcd
Viewing Angle		$I_F=20\text{mA}$	---	120	---	deg

Table 1-2 Absolute Maximum Ratings at Ts=25°C

Notes

1. 1/10 Duty cycle, 0.1ms pulse width.

1.6 Bin Range Of Forward Voltage and Luminous Intensity (IF=20mA)

BIN (IF=20mA)

Table 1-3 Bin Range Of Luminous Intensity

BIN CODE	IF=20mA Test			
	Min(mcd)	Max(mcd)	Min(lm)	Max(lm)
30	2150	2250	6.00	6.25
31	2250	2350	6.25	6.50
32	2350	2450	6.50	6.75
33	2450	2550	6.75	7.00
34	2550	2650	7.00	7.25
35	2650	2750	7.25	7.50
36	2750	2850	7.50	7.75
37	2850	2950	7.75	8.00
38	2950	3050	8.00	8.25
39	3050	3150	8.25	8.50
40	3150	3250	8.50	8.75
41	3250	3350	8.75	9.00
42	3350	3450	9.00	9.25

Table 1-4 Bin Range Of Forward Voltage

BIN CODE	Min.	Max.	Unit	Condition
V0	2.7	2.8	V	IF=20mA
V1	2.8	2.9		
V2	2.9	3.0		
V3	3.0	3.1		
V4	3.1	3.2		
V5	3.2	3.3		

Notes

VF Tolerance: $\pm 0.03V @ IF= 20mA @ Ta=25^{\circ}C$

IV Tolerance: $\pm 3% @ IF= 20mA @ Ta=25^{\circ}C$

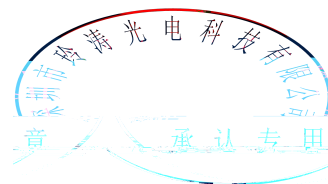

Fig. 1-5 The C.I.E. 1931 Chromaticity Diagram:

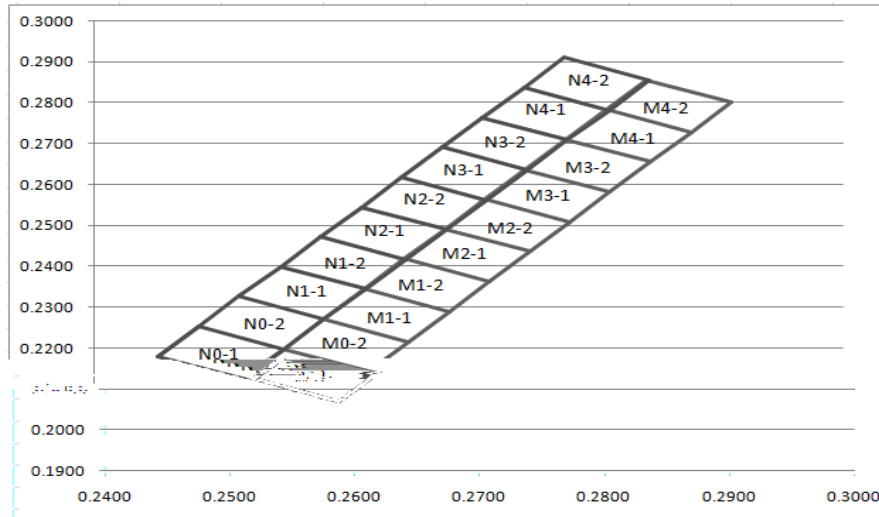

Table 1-6 Bin Range of Chromaticity Coordinates Block

N0-1	0.2451	0.2180	N0-2	0.2484	0.2253	N1-1	0.2516	0.2326
	0.2484	0.2253		0.2516	0.2326		0.2549	0.2399
	0.2552	0.2198		0.2584	0.2271		0.2617	0.2344
	0.2519	0.2125		0.2552	0.2198		0.2584	0.2271
N1-2	0.2549	0.2399	N2-1	0.2581	0.2472	N2-2	0.2614	0.2545
	0.2581	0.2472		0.2614	0.2545		0.2646	0.2618
	0.2649	0.2417		0.2682	0.2490		0.2714	0.2563
	0.2617	0.2344		0.2649	0.2417		0.2682	0.2490
N3-1	0.2646	0.2618	N3-2	0.2679	0.2691	N4-1	0.2711	0.2764
	0.2679	0.2691		0.2711	0.2764		0.2744	0.2837
	0.2747	0.2636		0.2779	0.2709		0.2812	0.2782
	0.2714	0.2563		0.2747	0.2636		0.2779	0.2709
N4-2	0.2744	0.2837	M0-1	0.2519	0.2125	M0-2	0.2552	0.2198
	0.2776	0.2910		0.2552	0.2198		0.2584	0.2271
	0.2844	0.2855		0.2620	0.2143		0.2652	0.2216
	0.2812	0.2782		0.2587	0.2070		0.2620	0.2143
M1-1	0.2584	0.2271	M1-2	0.2616	0.2345	M2-1	0.2648	0.2418
	0.2616	0.2345		0.2648	0.2418		0.2681	0.2491
	0.2684	0.2290		0.2716	0.2363		0.2749	0.2436
	0.2652	0.2216		0.2684	0.2290		0.2716	0.2363
M2-2	0.2681	0.2491	M3-1	0.2713	0.2564	M3-2	0.2745	0.2637
	0.2713	0.2564		0.2745	0.2637		0.2777	0.2710
	0.2781	0.2509		0.2813	0.2582		0.2845	0.2655
	0.2749	0.2436		0.2781	0.2509		0.2813	0.2582

M4-1	0.2777	0.2710	M4-2	0.2810	0.2783
	0.2810	0.2783		0.2842	0.2856
	0.2878	0.2728		0.2910	0.2801
	0.2845	0.2655		0.2878	0.2728

Fig. 1-7 The C.I.E. 1931 Chromaticity Diagram:

	0.2355	0.1858		0.2399	0.1956		0.2442	0.2053
MN00-1	0.2399	0.1956	MN00-2			MN0-1		

1.7 Typical Optical Characteristics Curves

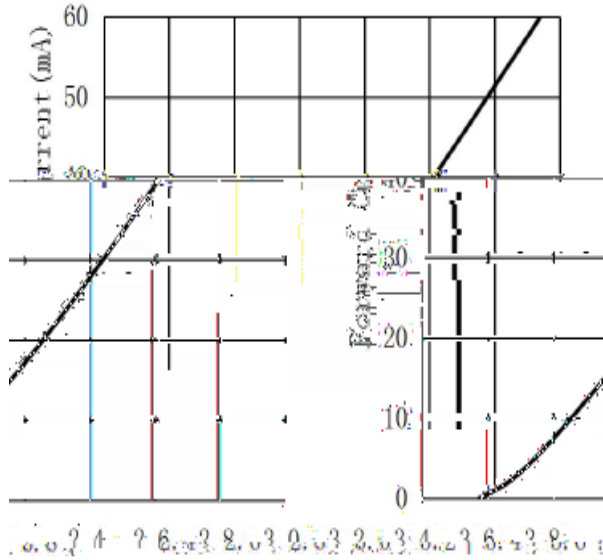

Fig. 1-7 Forward Voltage Vs Forward Current

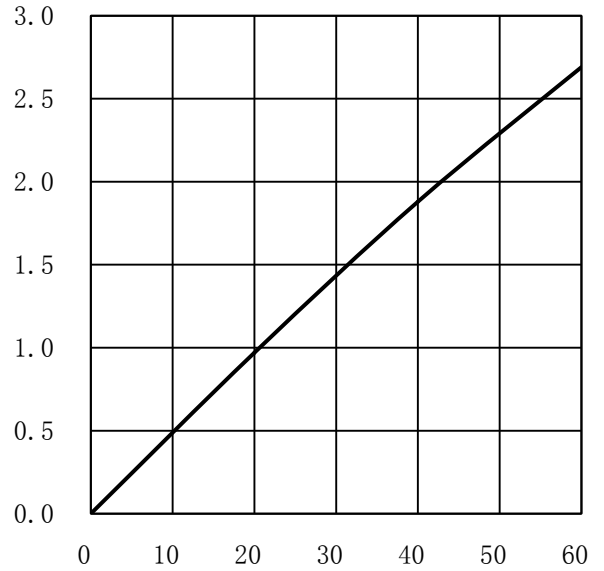

Fig. 1-8 Forward Current Vs Relative Intensity

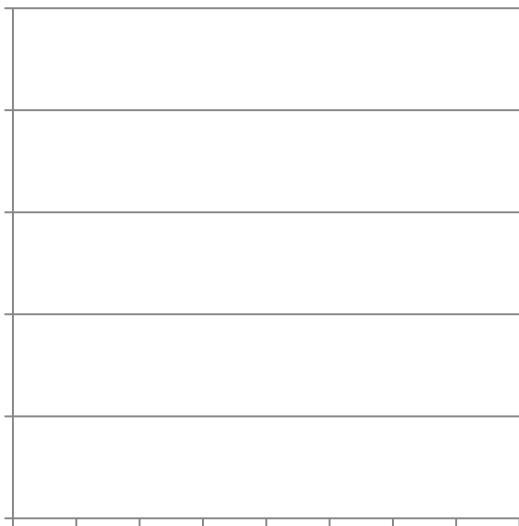

Fig. 1-10 Spectrum Distribution

Fig 1-9 Solder Temperature Vs Forward Current

2. Packaging

Packaging Specification

Package:5000pcs/reel.

5000pcs

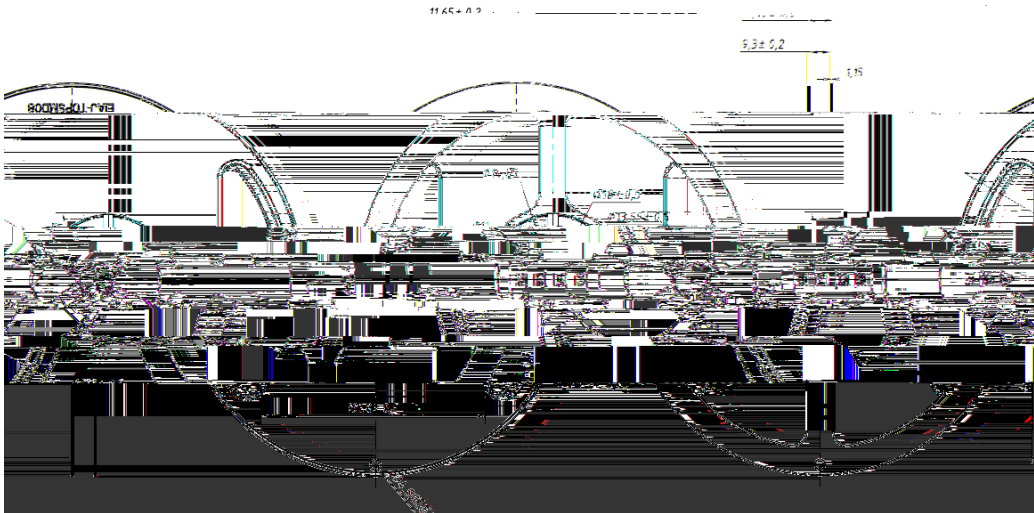

2.1.1 Carrier Tape Dimension

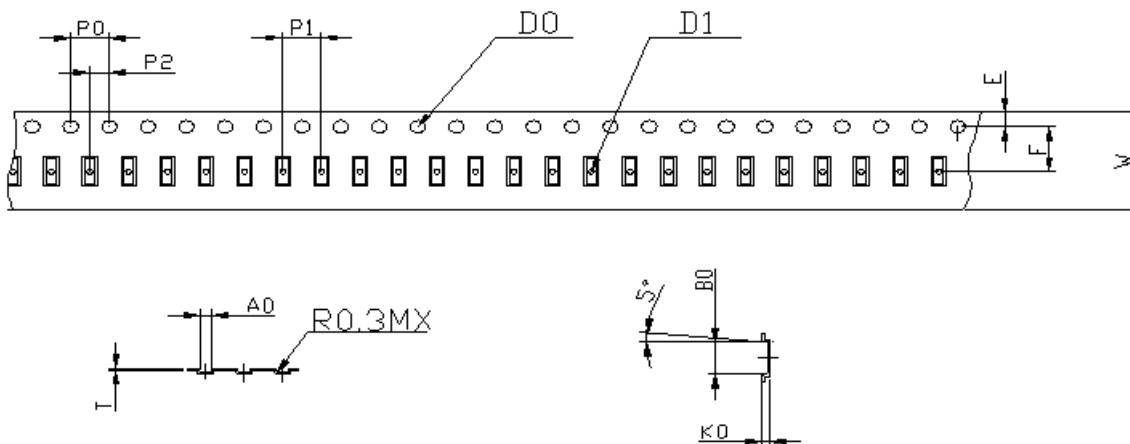

P0	4.00±0.10	P2	2±0.05	P1	4.00±0.10	D0	1.60±0.10	D1	0.60±0.10
E	1.75±0.10	F	3.50±0.10	W	8.00±0.20	A0	0.85±0.10	T	0.20±0.10
B0	2.80±0.10	K0	0.55±0.10						

Fig.2-1 Carrier Tape Dimension

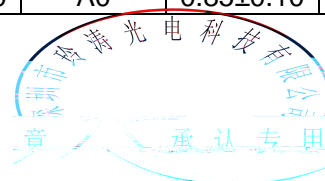

Notes

The tolerances unless mentioned $\pm 0.2\text{mm}$. Unit : mm

±

2.1.2 Label Form Specification

Table 2-2 Label Map



Table 2-3 Label Form Specification

PART NO.	Part Number
BIN CODE	Bin Code
IV	Luminous intensity
V _F	Forward Voltage
WL	Wavelength
QTY	Packing Quantity
DATE	Made Date
LOT NO	Lot Number

2.2 Moisture Resistant Packing

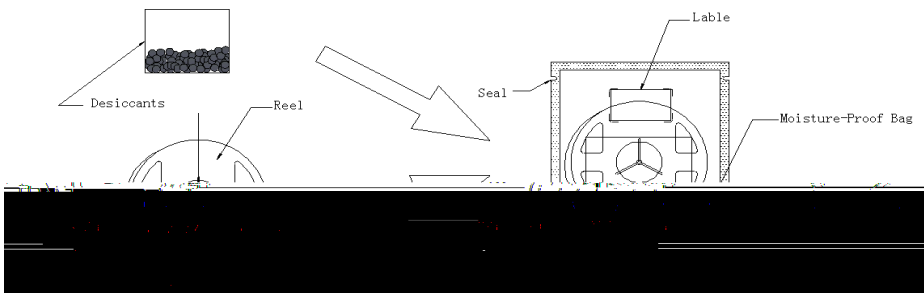

Fig.2-4 Moisture Resistant Packing

2.3 Cardboard Box

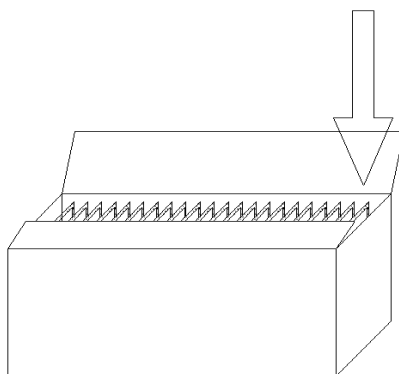
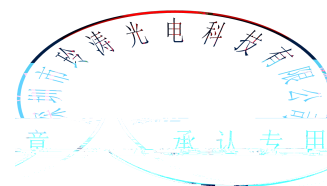

Fig.2-5 Cardboard Box



2.4 Reliability Test Items And Conditions

Table 2-6 Reliability Test Items And Conditions

TestItems	Test Condition	Time	Quantity	Ac/Re
				/

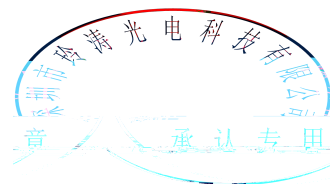

Luminous Flux		$I_F=20\text{mA}$	$<L.S.L^*)\times 0.7$	-

Notes

- 1.U.S.L: Upper standard level L.S.L: Lower standard level
- 2.The above reliability tests is based on the verification of a single/strip LED of LT existing experimental platform,the reliability experiment was taken under good heat dissipation conditions. when customers applies the LED to the series and parallel circuit, should take consideration of all the factors such as the current, voltage distribution, heat dissipation and others.
- 3.The technical information shown in the data sheets is limited to the typical characteristics and circuit examples of the referenced products. It does not constitute the warranting of industrial property nor the granting of any license.

3. SMT Reflow Soldering Instructions SMT

3.1 SMT Reflow Soldering Instructions

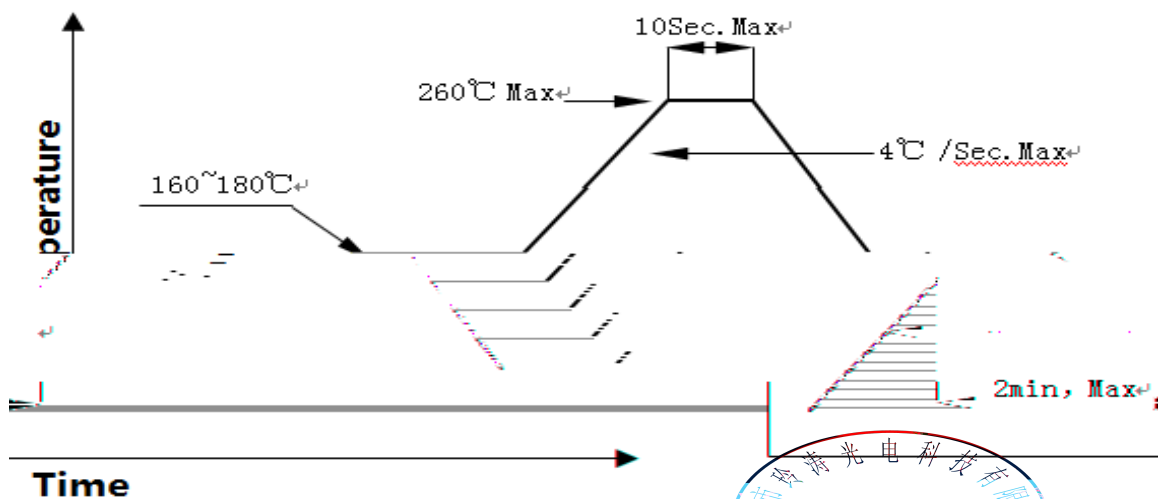

Fig.3-1 SMT Reflow Soldering Map

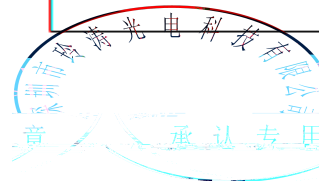

Fig.3-2 SMT Reflow Soldering Instructions SMT

Average temperature rise speed	T_{smax} T_P	5 °C/ Max 5 °C/ s
Preheating: minimum temperature	(T_{smin})	160 °C
Preheating: Max temperature	(T_{smax})	260 °C
Preheating: Time	T_{smin} T_{smax}	60 - 120 60s-120s
Time limited to maintain high temperature: the temperature	(T_L)	217 °C
Time limited to maintain high temperature: The Time	(t_L)	60 Max 60s
Peak /Classification of temperature: /	(T_P)	260 °C
Time limit classification of peak temperature time	t_p	10 Max 10s
(T_P) 5 °C actual peak temperature (TP)	Hold time within 5 ° C with the	30 Max 30s
Cooling speed		6 °C/ Max 6 °C/ s
25 °C	Needed time from 25 °C to T_p	8 Max 8 minutes

content of Bromine element and Chlorine element in the external materials of the application products is required to be less than 1500PPM. This is provided for informational purposes only and is not a warranty or endorsement.

(3) VOCs (Volatile organic compounds) emitted from materials used in the construction of fixtures can penetrate silicone encapsulants of LEDs and discolor when exposed to heat and photonic energy. The result can be a significant loss of light output from the fixture. Knowledge of the properties of the materials selected to be used in the construction of fixtures can help prevent these issues. LT advises against the use of any chemicals or materials that have been found or are suspected to have an adverse effect on device performance or reliability. To verify compatibility, LT recommends that all chemicals and materials be tested in the specific application and environment for which they are intended to be used. Attaching LEDs, do not use adhesives that outgas organic vapor.

(4) Handle the component along the side surface by using forceps or appropriate tools; do not directly touch or handle the silicone lens surface, it may damage the internal circuitry.

(5) In designing a circuit, the current through each LED must exceed the absolute maximum rating specified for each LED. In the meanwhile, resistors for protection should be applied, otherwise slight voltage shift will cause big current change, burn out may happen. The driving circuit must be designed to allow forward voltage only when it is ON or OFF. If the reverse voltage is applied to LED, migration can be generated resulting in LED damage.

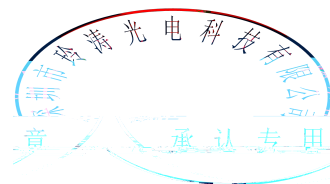

(6) Thermal Design is paramount importance because heat generation may result in the Characteristics decline, such as brightness decreased, Color change and so on. Please consider the heat generation of the LEDs when making the system design. LED

(7) Compared to standard encapsulants, silicone is generally softer, and the surface is more likely to attract dust, requiring special care during processing. In cases where a minimal level of dirt and dust particles cannot be guaranteed, a suitable cleaning solution must be applied to the surface after the soldering of components. LT suggests using isopropyl alcohol for cleaning. In case other solvents are used, it must be assured that these solvents do not dissolve the package or resin. Ultrasonic cleaning is not recommended. Ultrasonic cleaning may cause damage to the LED.

Table 4-1 Storage

Conditions		Temperature	Humidity	Time
Storage	Before Opening Aluminum Bag	30	75%	Within 1 Year From Date
	After Opening Aluminum Bag	30	60%	24hours 24
Baking		60± 5	-	24hours 24

(8) If the moisture absorbent material (silica gel) has faded away or the LEDs have exceeded the storage time, baking treatment should be performed after unpacking and based on the

following condition (65 ± 5) °C for above 24 hours.

±

If the package is flatulence or damaged, please notify the sales staff to assist.

(9) Similar to most Solid state devices; LEDs are sensitive to Electro-Static Discharge (ESD) and Electrical Over Stress (EOS).

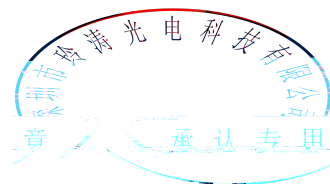

Version History/

Date	Revisor	Version	Verifier	Remarks
2019/8/10		E/0		

