

SPECIFICATION

REFOND P/N

RF-MTD**2T08-E1

Mass Product

Contents

1. LED Module Description	
2.LED Module Specification	
2.1 Optical-electrical Characteristics(Absolute Maximum Ratings At $T_s=25$)	.4
2.2 LED Module Schematic And Interface Definition	6
2.3 LED Module rule of naming	6
3. Product Specification	
3.1 Outline Dimension	7
4. LED Module Reliability Test	
5. LED Module Materials Performance Test And Method At $T_a=25$	
6.Packing Criterion	
6.1 Package Diagram /	10
6.2 Blister box Dimensions/	10
6.3 Carton Dimensions/	10
6.4 Carton silk printing/	11
6.5 Label Form Specification/	11
7. Handling Precautions	

1. LED Module Description

LED Module designed according to the market mainstream

2.LED Module Specification

2.1 Optical-electrical Characteristics(Absolute Maximum Ratings At Ts=25)

Tab.2-1 Optical-electrical Characteristics

7 1 . x

Refond PN	Module Characteristics						
	Current mA	Voltage(V)		Power(W)		Module LM	
	Typ	Min	Max	Min	Max	Min	Max
RF-MTD302T08-E1 2870-3220K	180	39	46.5	6.868	7.37	1100	1284
RF-MTD352T08-E1 3220-3700K	180	39	46.5	6.868	7.37	1156	1352
RF-MTD402T08-E1 3700-4275K	180	39	46.5	6.868	7.37	1217	1423
RF-MTD502T08-E1 4740-5250K	180	39	46.5	6.868	7.37	1217	1423
RF-MTD652T08-E1 5910-7175K	180	39	46.5	6.868	7.37	1217	1423

2.2 LED Module Schematic And Interface Definition

Fig.2-2ED Module connection

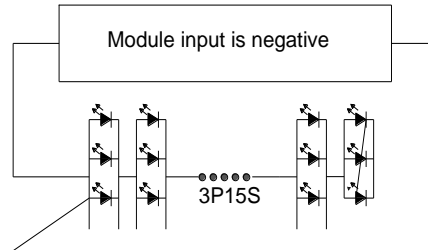

2.3 LED Module rule of naming :

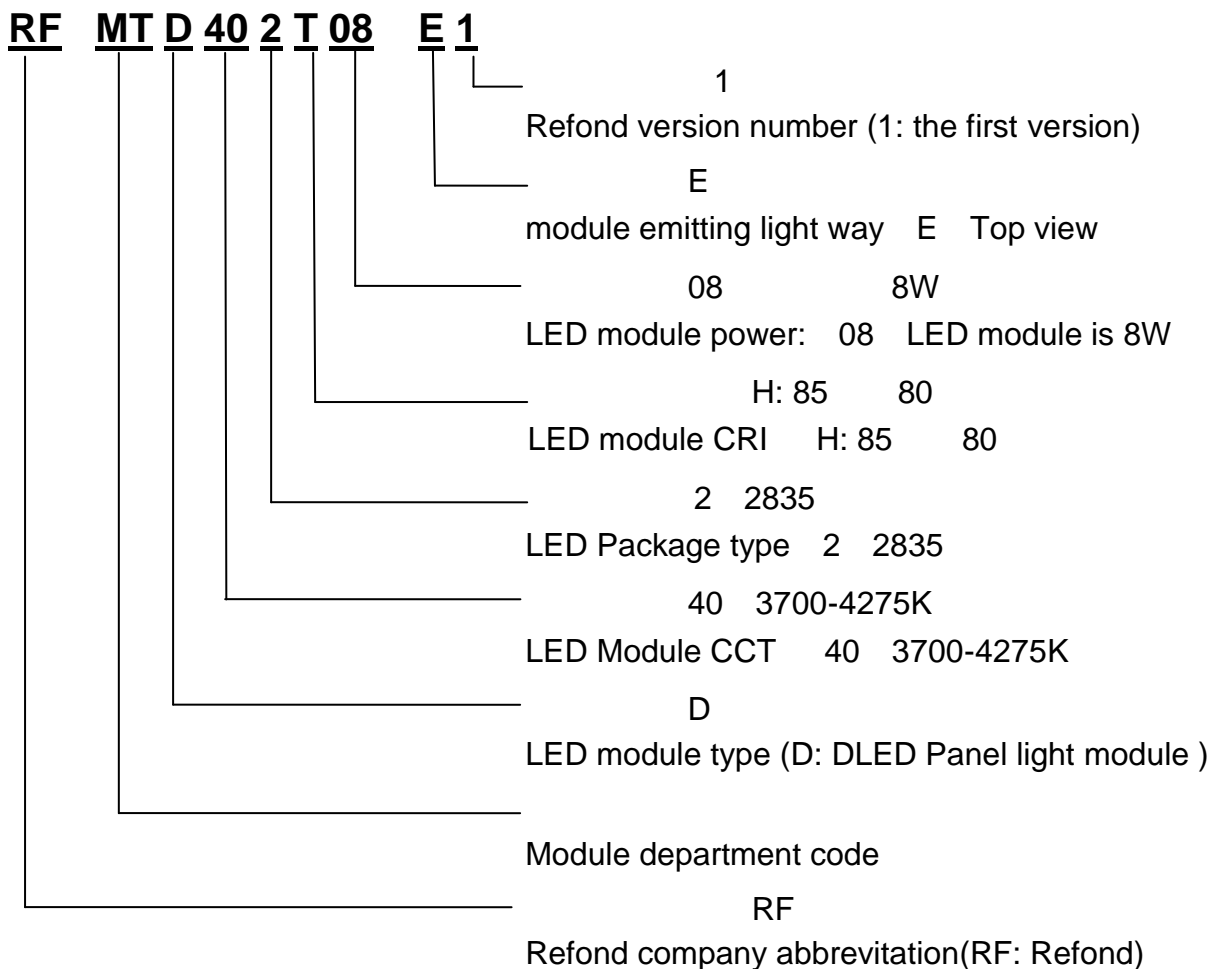

3. Product Specification

3.1 Outline Dimension

4. LED Module Reliability Test

Tab 4-1 Light Bar Reliability Test

Test Item/	Test Conditions/	Test Time/	Number Of Test/	Judgement Criteria/
Operating Life At Room Temperature/	$T_A=25$ $I_F=180\text{mA}$ $T_J<115$	500Hrs	0/6	1. $V_f<110\%$, $\text{CIE } x/ y<0.015$ 2.No catastrophic failure
Operating Life At High Temperature/	$T_A=60$ $I_F=180\text{mA}$ $T_J<115$	500Hrs	0/6	
Operating Life At High Temperature And Humidity/	60 $R_H=90\%$ I			

5. LED Module Materials Performance Test And Method At Ta=25

Tab 5-1 Light Bar Materials Performance Test And Method Ta=25

Test Item	Test Conditions	Test Methods
LED Optical-electrical Characteristics LED	Compliance With Specifications/	

6.Packing Criterion

6.1 Package Diagram /

Fig 8-1 Package Diagram /

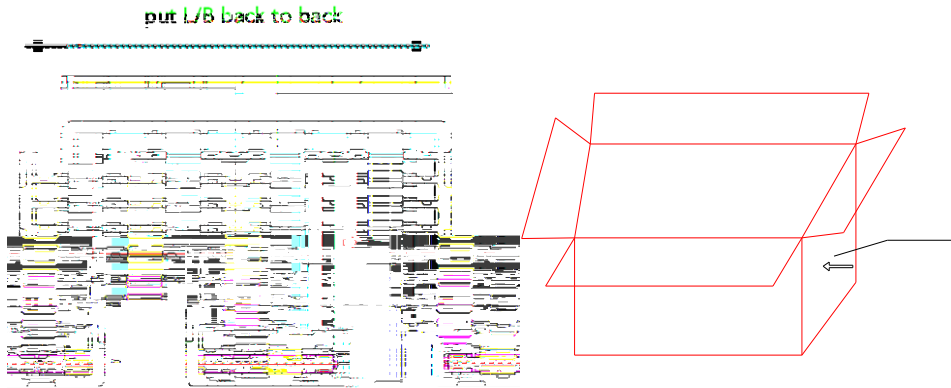

6.2 Blister box Dimensions/

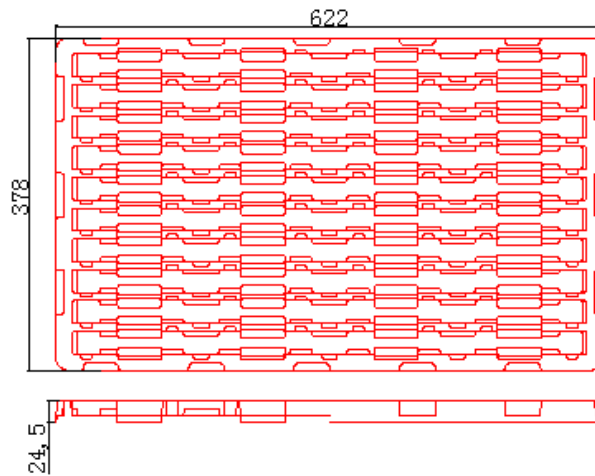

6.3 Carton Dimensions/

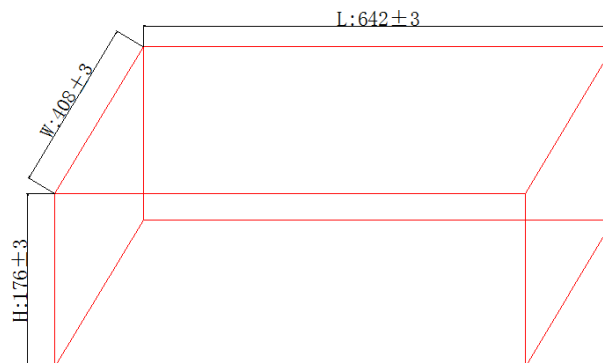

6.4 Carton silk printing/

REFOND LOGO

Pay attention to identify

6.5 Label Form Specification/



7. Handling Precautions

(1) LED operating environment and sulfur element composition cannot be over 100PPM in the LED mating usage material. This is provided for informational purposes only and is not a warranty or endorsement.LED

(2) In order to prevent external material from getting into the inside of LED, which may cause the malfunction of LED, the single content of Bromine element is required to be less than 900PPM,the single content of Chlorine element is required to be less than 900PPM,the total content of Bromine element and Chlorine element in the external materials of the application products is required to be less than 1500PPM. This is provided for informational purposes only and is not a warranty or endorsement.

(3) VOCs (Volatile organic compounds) emitted from materials used in the construction of fixtures can penetrate silicone encapsulants of LEDs and discolor when exposed to heat and photonic energy. The result can be a significant loss of light output from the fixture. Knowledge of the properties of the materials selected to be used in the construction of fixtures can help prevent these issues. Refond advises against the use of any chemicals or materials that have been found or are suspected to have an adverse affect on device performance or reliability. To verify compatibility, Refond recommends that all chemicals and materials be tested in the specific application and environment for which they are intended to be used. Attaching LEDs, do not use adhesives that outgas organic vapor.

(4) Handle the component along the side surface by using forceps or appropriate tools; do not directly touch or Handle the silicone lens surface, it may damage the internal circuitry.

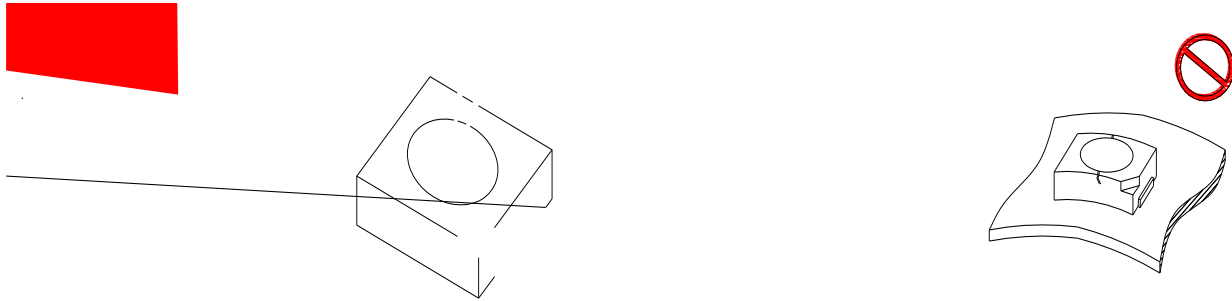

(5) In designing a circuit, the current through each LED can not be exceed the absolute maximum rating specified for each LED. In the mean while, resistors for protection should be applied, otherwise slight voltage shift will cause big current change, burn out may happen. The driving circuit must be designed to allow forward voltage only when it is ON or OFF. If the reverse voltage is applied to LED, migration can be generated resulting in LED damage.

(6) Thermal Design is paramount importance because heat generation may result in the Characteristics decline, such as brightness decreased, Color change and so on. Please consider the heat generation of the LEDs when making the system design.LED

(7) Compared to standard encapsulants, silicone is generally softer, and the surface is more likely to attract dust , requiring special care during processing. In cases where a minimal level of dirt and dust particles cannot be guaranteed, a suitable cleaning solution must be applied to the surface after the soldering of components. Refond suggests using isopropyl alcohol for cleaning. In case other solvents are used, it must be assured that these solvents do not dissolve the package or resin. Ultrasonic cleaning is not recommended. Ultrasonic cleaning may cause

damage to the LED.

(8) Similar to most Solid state devices; LEDs are sensitive to Electro-Static Discharge (ESD) and Electrical Over Stress (EOS).

9>.NO warping or twisting the Light Bar more than 10°. Forbidding holding the LED part or connector part when handling.

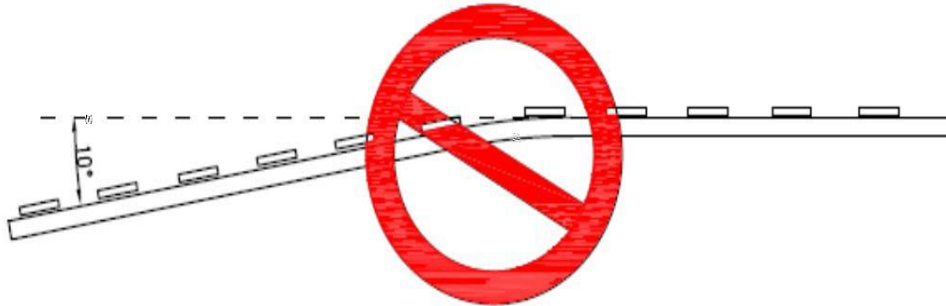

(10) Other points for attention, please refer to our relevant information.



Declare

This specification is written both in English and in Chinese and the latter is formal.