

SPECIFICATION

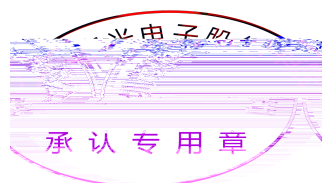

Contents

| | |
|--|----|
| 1. Description | |
| 1.1 General Description | 3 |
| 1.2 Features | 3 |
| 1.3 Application | 3 |
| 1.4 Package Dimension | 4 |
| 1.5 Product Parameters | 5 |
| 1.6 Typical optical characteristics curves | 6 |
| 2. Packaging | |
| 2.1 Packaging Specification | 9 |
| 2.1.1 Carrier Tape Dimension | 9 |
| 2.1.2 Reel Dimension | 10 |
| 2.1.3 Label Form Specification | 10 |
| 2.2 Moisture Resistant Packing | 11 |
| 2.3 Cardboard Box | 11 |
| 2.4 Reliability Test Items And Conditions | 12 |
| 2.5 Criteria For Judging Damage | 12 |
| 3. SMT Reflow Soldering Instructions SMT | |
| 3.1 SMT Reflow Soldering Instructions SMT | 13 |
| 3.1.1 Soldering Iron | 14 |
| 3.1.2 Repairing | 14 |
| 3.1.3 Cautions | 15 |
| 4. Handling Precautions | |
| 4.1 Handling Precautions | 15 |

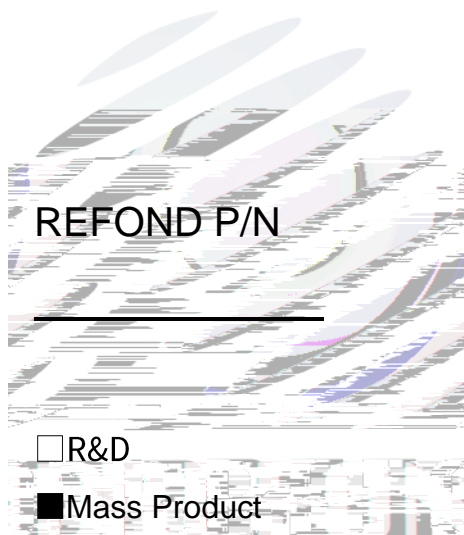
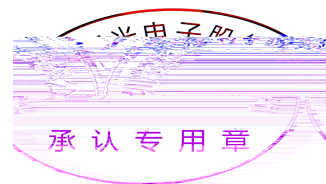

1. Description

1.1 General Description

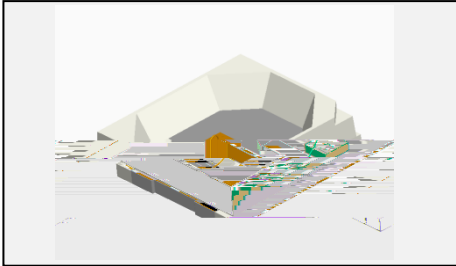

This production use the PLCC-2 package outline size 2.8*3.5*0.65mm

1.2 Features

- ▶ PLCC package.
- ▶ Viewing angle:120°.
- ▶ Suitable for all SMT assembly and solder process.
- ▶ Available on tape and reel.
- ▶ Moisture sensitivity level: Level 3.
- ▶ RoHS compliant.

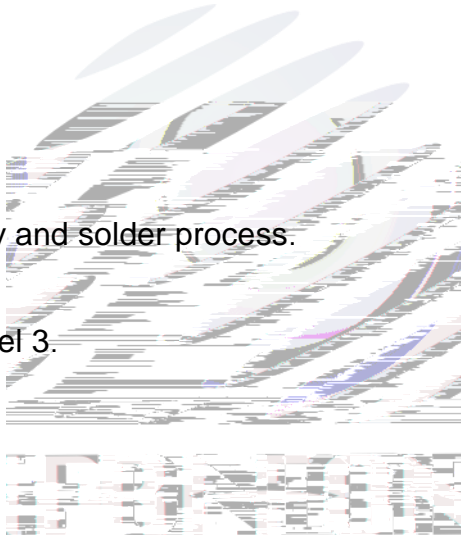

1.3 Application

- ▶ Flower production.
- ▶ Tissue culture.
- ▶ Plant factory.
- ▶ Refreshment.
- ▶ General use.

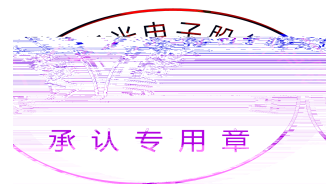

1.4 Package Dimension

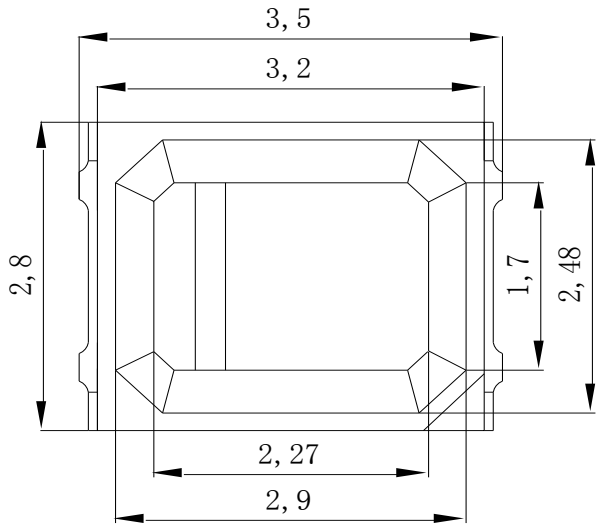

Fig.1-1 Top view

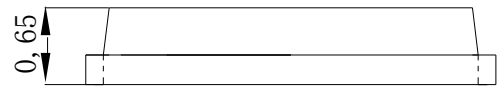

Fig.1-2 Side view

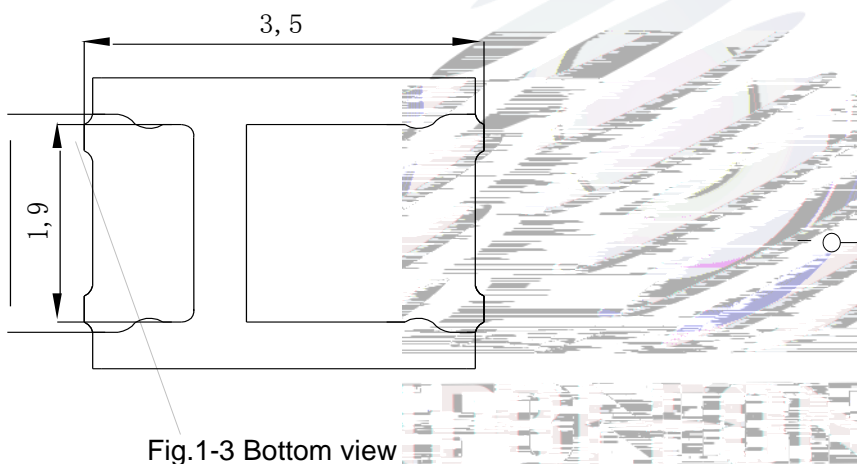

Fig.1-3 Bottom view

Fig.1-4 Polarity

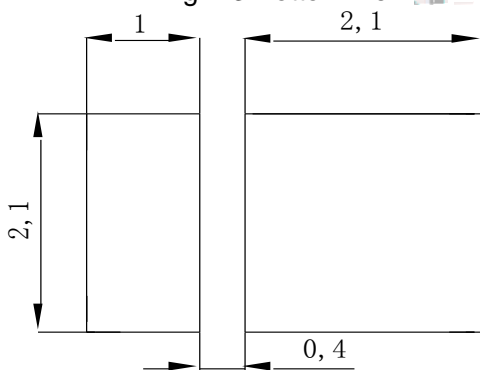
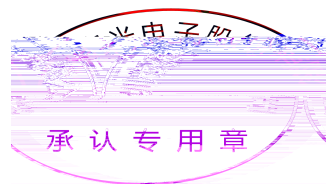

Fig.1-5 Soldering patterns

Notes:

1. All dimensions units are millimeters.
2. All dimensions tolerances are $\pm 0.2\text{mm}$ unless otherwise noted.



1.5 Product Parameters

Table 1-1 Electrical / Optical Characteristics at Ts=25°C

| Item | Symbol | Test Condition | Value | | | Unit |
|---------------------|----------------|--------------------|-------|-----|------|-----------------------------|
| | | | Min. | Typ | Max. | |
| Forward Voltage | V_F | $I_F=150\text{mA}$ | 1.8 | 2.2 | 2.6 | V |
| Reverse Current | I_R | $V_R=5\text{V}$ | --- | --- | 10 | μA |
| Total radiant flux | Φ_e | $I_F=150\text{mA}$ | 90 | 112 | 140 | mW |
| Peak wavelength | λ_p | $I_F=150\text{mA}$ | 730 | 735 | 740 | nm |
| Viewing Angle | 2 θ 1/2 | $I_F=150\text{mA}$ | --- | 120 | --- | deg |
| Thermal Resistance. | R_{THJ-S} | $I_F=150\text{mA}$ | --- | 15 | --- | $^{\circ}\text{C}/\text{W}$ |

Table 1-2 Absolute Maximum Ratings at Ts=25°C

| Parameter | Symbol | Rating | Units |
|-------------------------------|-----------|------------|-------|
| Power Dissipation | P_D | 0.4 | W |
| Forward Current | I_F | 150 | mA |
| Peak Forward Current | I_{FP} | 200 | mA |
| Reverse Voltage | V_R | 5 | V |
| Electrostatic Discharge (HBM) | E_{SD} | 2000 | V |
| Operating Temperature | T_{OPR} | -40 ~ +85 | |
| Storage Temperature | T_{OPR} | -40 ~ +100 | |
| Junction Temperature | T_J | 115 | |

Notes:

1. 1/10 Duty cycle, 0.1ms pulse width.
2. The above forward voltage measurement allrem

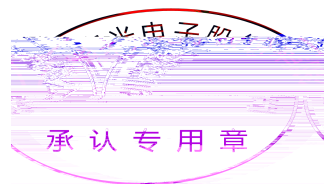
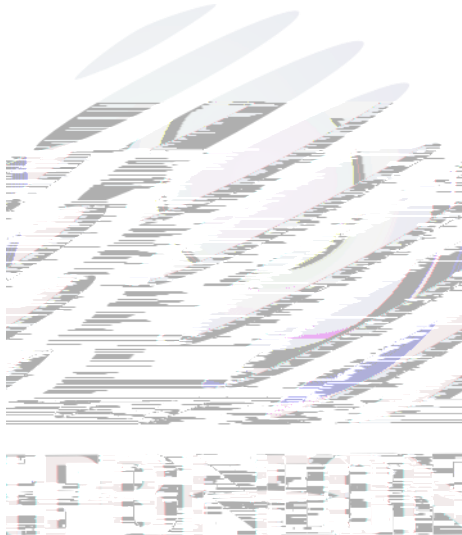

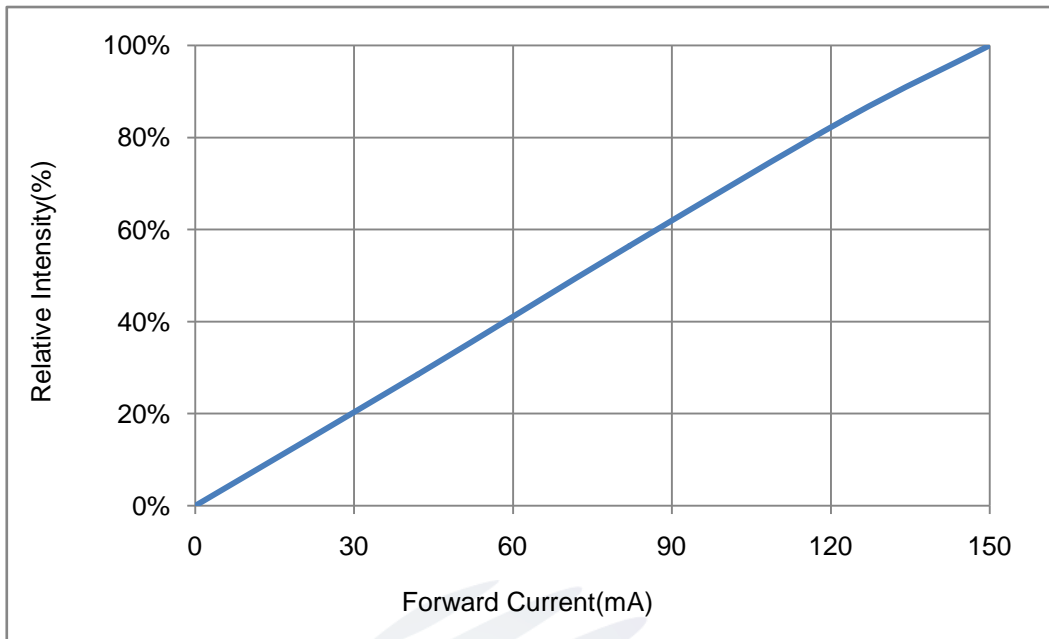

Fig.2- Forward Current Vs. Relative Power

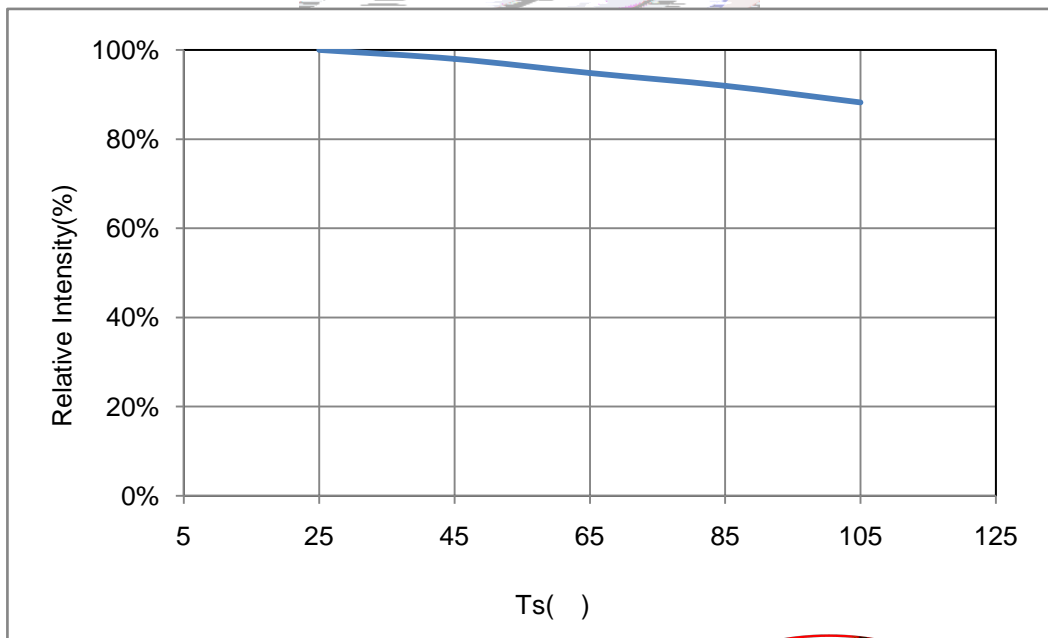

Fig.3-Solder Temperature VS. Relative Power



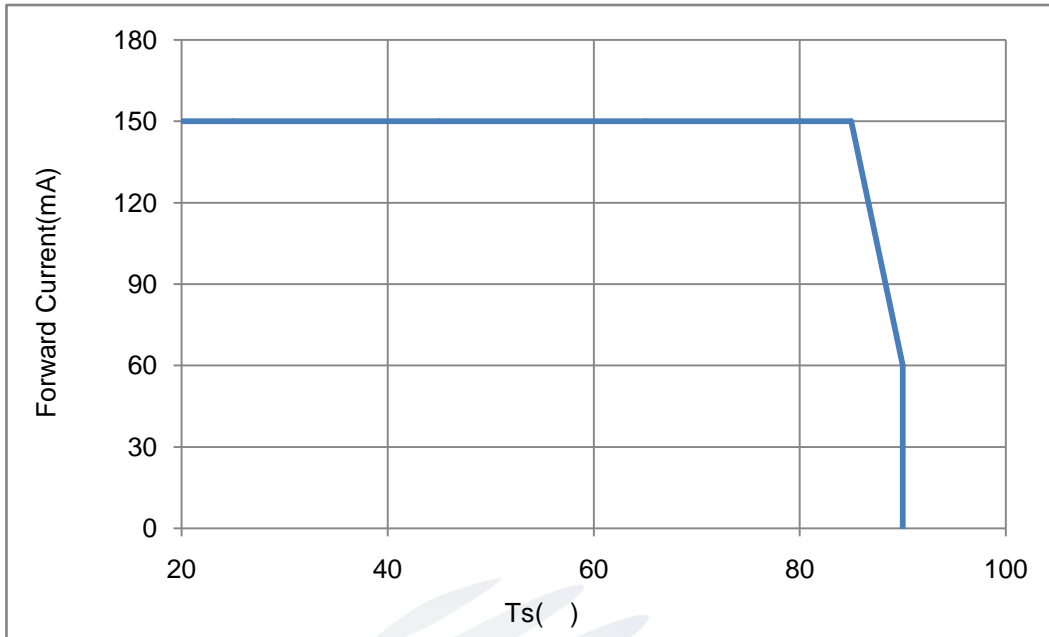

Fig.4-Ts Temperature VS. Forward Current

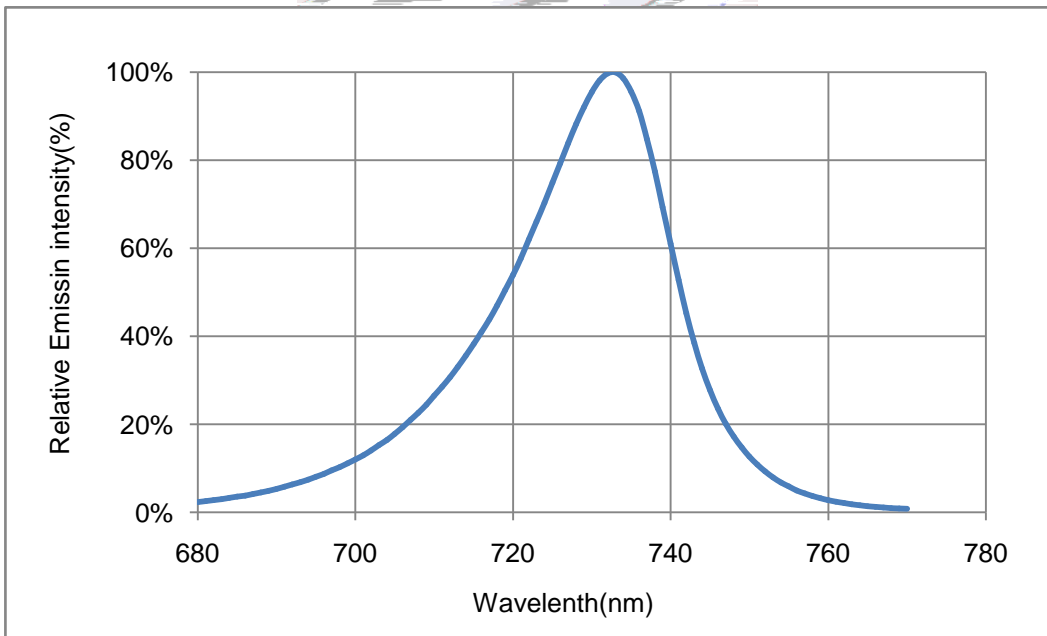
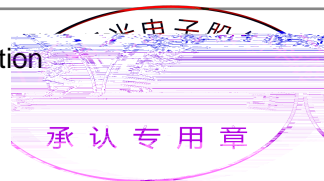

Fig.5-Spectrum Distribution



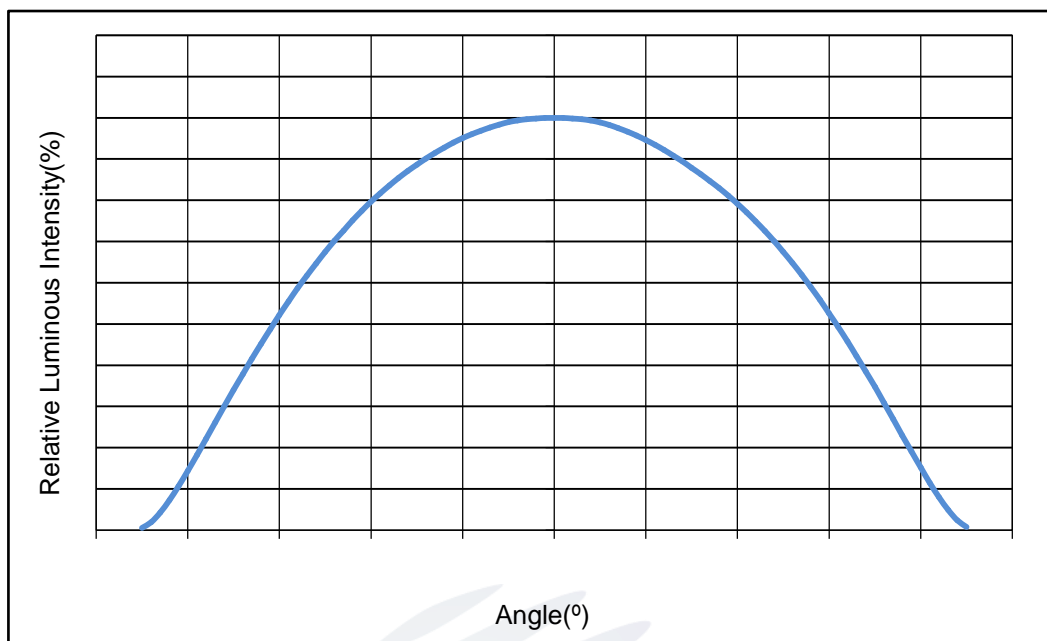

Fig.6- Radiation Diagram

2. Packaging

2.1 Packaging Specification

Package:4000pcs/reel.

2.1.1 Carrier Tape Dimension

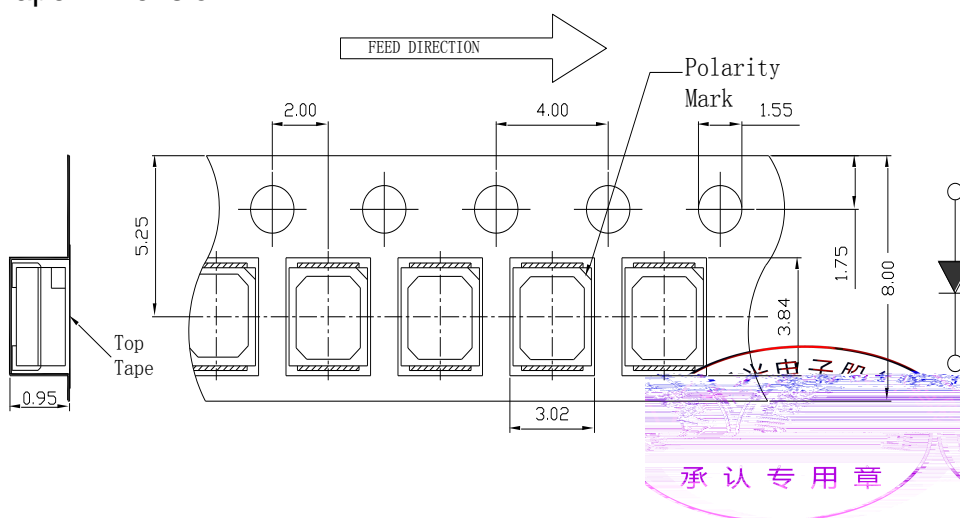

Fig.2-1 Carrier Tape Dimension

2.1.2 Reel Dimension

Table 2-1 Reel Dimension



| | |
|---|------------|
| A | 12±0.1mm |
| B | 178±1mm |
| C | 60±1mm |
| D | 13.0±0.5mm |

Fig.2-2 Reel Dimension

Notes:

The tolerances unless mentioned ±0.1mm. Unit : mm .

2.1.3 Label Form Specification

Table 2-2 Label Form Specification

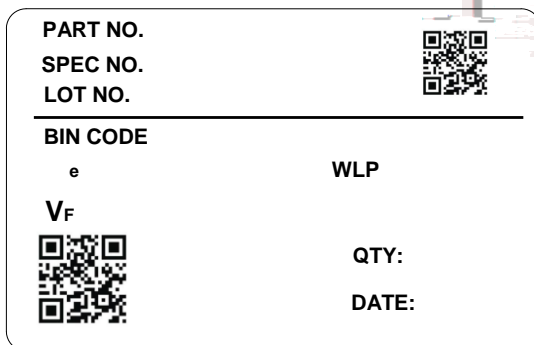

| | |
|----------------|------------------|
| PART NO. | Part Number |
| SPEC NO. | Spec Number |
| LOT NO. | Lot Number |
| BIN CODE | Bin Code |
| Φ _e | Radiation flux |
| V _F | Forward Voltage |
| WLP | Wavelength |
| QTY | Packing Quantity |
| DATE | Made Date |

Fig. 2-3 Label Form Specification

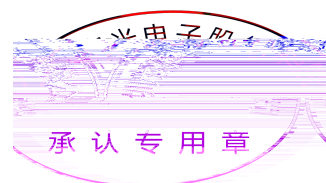

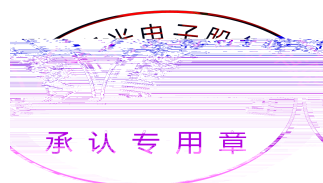
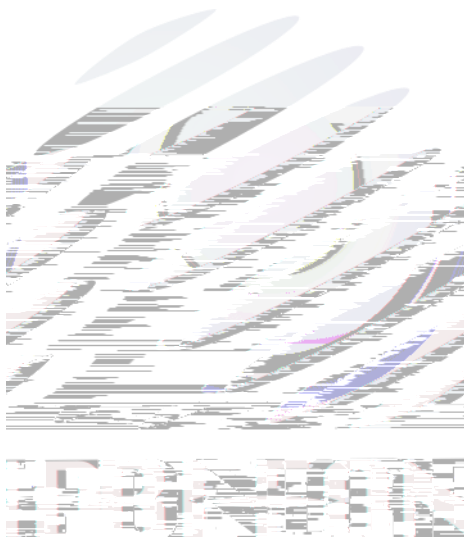

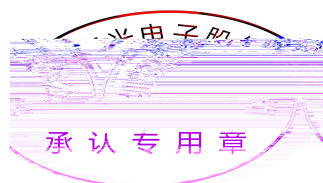
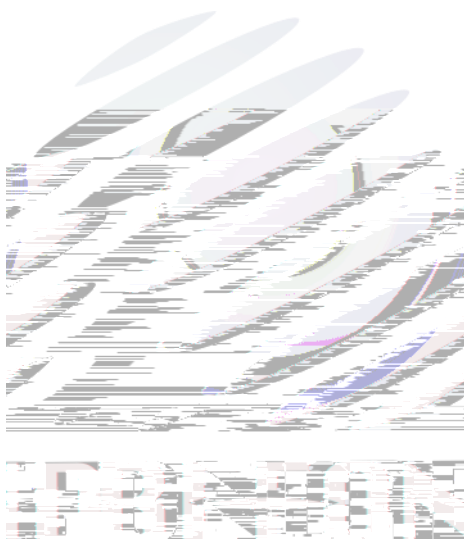

Notes:

1. U.S.L: Upper standard leve. L.S.L: Lower standard level.
2. The above reliability tests is based on the verification of a single/strip LED of Refond's existing experimental platform, the reliability experiment was taken under good heat dissipation conditions. when customers applies the LED to the series and parallel circuit, should take consideration of all the factors such as the current, voltage distribution, heat dissipation and others.
3. The technical information shown in the data sheets is limited to the typical characteristics and circuit examples of the referenced products. It does not constitute the warranting of industrial property nor the granting of any license.

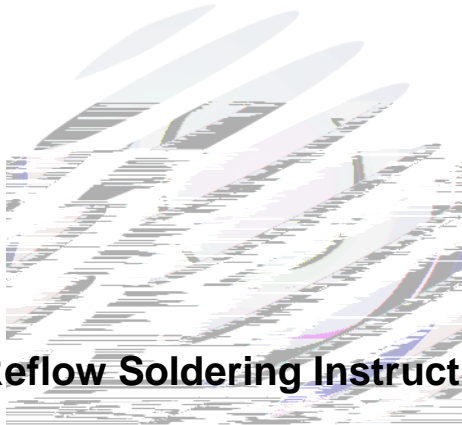

3. SMT Reflow Soldering Instructions SMT

3.1 SMT Reflow Soldering Instructions SMT

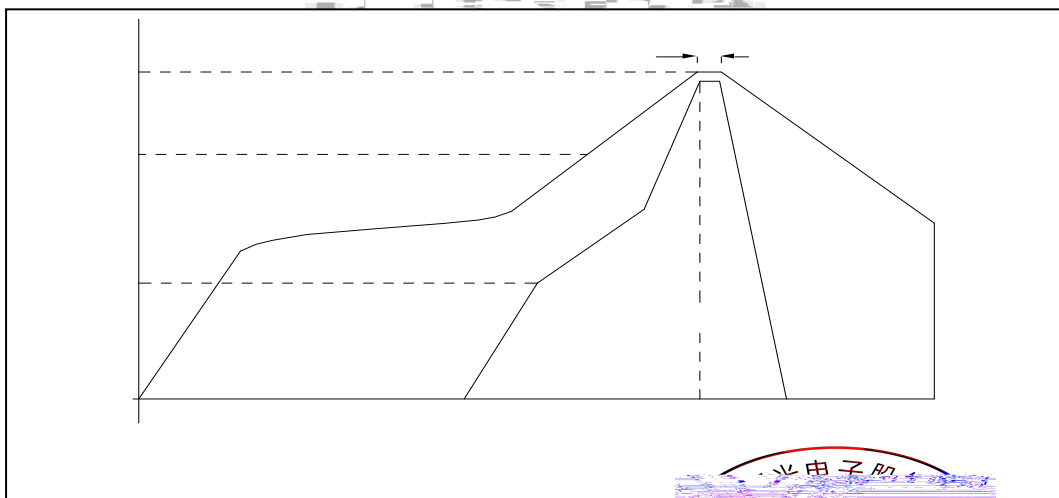

Fig.3-1 SMT Reflow Soldering Instructions SMT

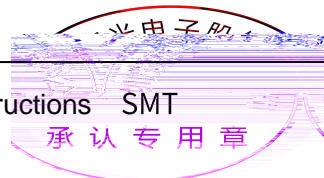
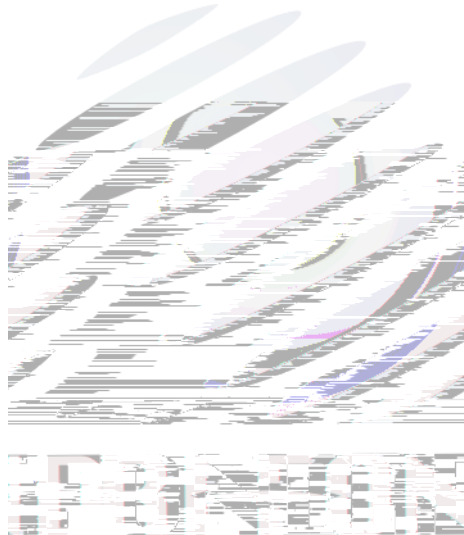

Table 3-1 SMT Reflow Soldering Instructions SMT

| | |
|--|-------------|
| Average temperature rise speed (T _{smax}) | Max 3 °C/ s |
| Preheating: minimum temperature (T _{smin}) | 150 °C |

Preheating: Max temperature (T_{smax})



(4) Handle the component along the side surface by using forceps or appropriate tools; Do not directly touch or Handle the silicone lens surface, it may damage the internal circuitry.

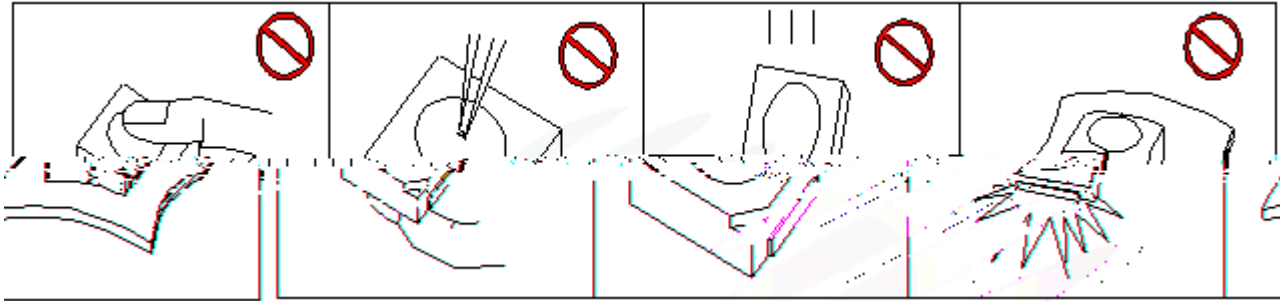

Fig 4-1 Operate Method

(5) In designing a circuit, the current through each LED can not exceed the absolute maximum rating specified for each LED. In the meanwhile, resistors for protection should be applied, otherwise slight voltage shift will cause big current change, burn out may happen. The driving circuit must be designed to allow forward voltage only when it is ON or OFF. If the reverse voltage is applied to LED, migration can be generated resulting in LED damage.

(6) Thermal Design is paramount importance because heat generation may result in the Characteristics decline, such as brightness decreased, Color change and so on. Please consider the heat generation of the LEDs when making the system design.

(7) Compared to standard encapsulants, silicone is generally softer, and the surface is more likely to attract dust, requiring special care during processing. In cases where a minimal level of dirt and dust particles cannot be guaranteed, a suitable cleaning solution must be applied to the surface after the soldering of components. Refond suggests using isopropyl alcohol for cleaning. In case other solvents are used, it must be assured that these solvents do not dissolve the package or resin. Ultrasonic cleaning is not recommended. Ultrasonic cleaning may cause damage to the LED.

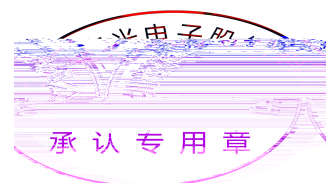

Table 4-1Storage

